

KÜCHENPROFI

Katalog 2015/2016



Design | Funktion | Qualität

- 
4-11 Serie Provence
 Gusseisen-Geschirr, WOK-Sets, Keramiktöpfchen usw.
- 
12-19 Servierkollektion
 ofenfestes Hartporzellan und ofenfeste Keramik
- 
23-26 Pasta
 original italienische Nudelmaschinen, Zubehör für Pasta
- 
27-28 Pizza
 Zubehör für Pizza
- 
29-38 Pâtissier
 Dekorierlöffel, Silikon-Set's, Ausstecher und weiteres Backzubehör
- 
39-48 Praktische Küchenhelfer
 Brotkästen, Küchenwaagen, Abgießsiebe und andere nützliche Helfer
- 
49-51 Passieren und Einkochen
 Trichter und Passiergeräte
- 
52-54 Schönes und Nützliches
 Lunchboxen, Löffelablagen und Papierrollenhalter
- 
55-58 Würze und Co.
 Mörser-Kollektion, Essig- und Ölsprüher, Muskatmühlen sowie Gemüseschäler
- 
59-60 Spargel
 Zubehör für die Spargelzeit
- 
61-69 Reibenvielfalt
 Reibenkollektion, Standreiben und Accessoires
- 
70-73 Timer und andere Helfer
 Klassische-/ Digitaltimer und Sanduhren
- 
74-77 Braten
 Braten-Zubehör und Thermometer
- 
78-84 Tee und Kaffee
 mit unverzichtbarem Zubehör und dem Tea-Boy
- 
85-87 Praktische Küchenhelfer
 Setzei-Ringe, Trocknerbälle, und Spülbürsten. Anspruchvolles Genießen.
- 
88-95 Grillen
 Unverzichtbares Zubehör
- 
96-102 Praktische Küchenhelfer
 Gadgets, Siebe uvm.
- 
96-110 Salatschleudern und mehr
 Salatschleudern, Kartoffel- und Spätzlepressen, Pommes Frites Schneider und Zitronenpressen
- 
111-116 Raclette, Fondue und Zubehör
 das Beste zum Kochen auf dem Tisch
- 
117-118 Crème Brûlée Accessoires
 für Einsteiger und Profis
- 
119-122 Kochgeschirr & Sonstiges
 Töpfe und Bräter, Siebe, Seiher und Schüsseln
- 
123-127 Scheren und Schneidebretter
 Geflügel, Kräuter und Co.
- 
128-135 Würzen und mehr
 Gewürzständer, Salz- und Pfeffermühlen – manuell und elektrisch
- 
136-139 Werbemittel
- 
140-145 Servicebereich
 Außendienst & Inhaltsverzeichnis

Die neue Guss-Kollektion

Profi-Qualität

- optimale Hitzeverteilung
- besonders energiesparend
- ergonomisch geformte Griffe
- Deckelknöpfe hitzebeständig bis 250°C
- für besonders schonendes & schmackhaftes Braten und Garen
- Lieferung in einer attraktiven Geschenkbox
- entworfen in Kooperation mit: **TASSILO VON GROLMAN DESIGN**





■ Kompetentes Sortiment, zeitloses sowie eigenständiges Design, kompromisslose Qualität und Verarbeitung auf TOP-Niveau, einzigartiges Preis-Leistungs-Verhältnis...das ist „Provence“!!!

■ 30 Jahre Garantie

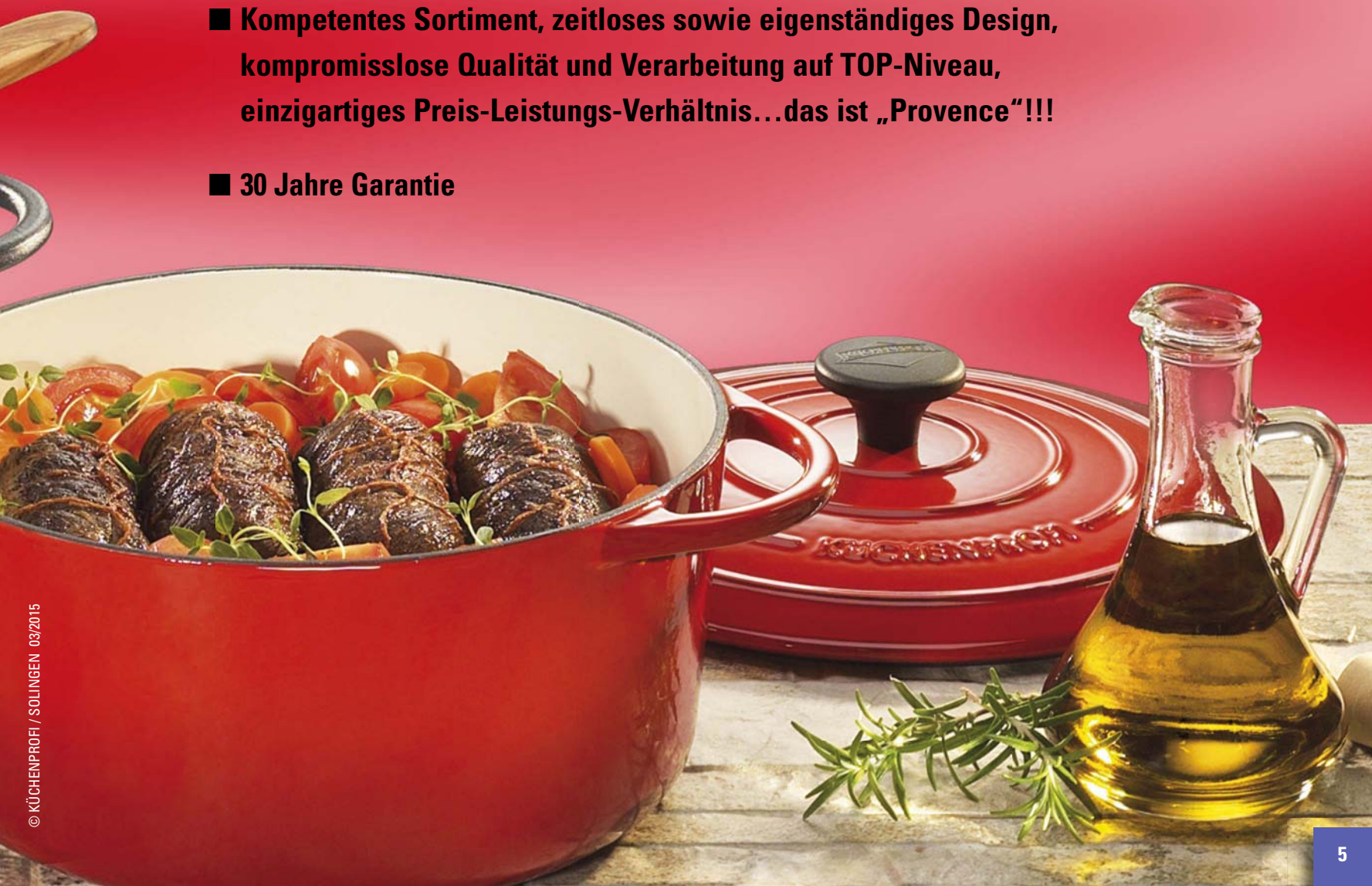

- für besonders schonendes & schmackhaftes Braten und Garen.
- Profi-Qualität
- optimale Hitzeverteilung ■ besonders energiesparend
- mit Plan-Boden für: Glaskeramik, Induktion, Halogen, Elektro, Gas

Bratentopf, rund mit Gussdeckel, schwarz

round french oven, with lid
cocotte ronde, avec couvercle
casseruola rotonda, con coperchio
cacerola redonda, con tapa
kookpan rond, met deksel

Ø cm	Höhe cm	Inhalt ltr.	Ø inch	Art.-Nr.	EAN	GP
24,0	11,5	4,2	9½	04 0100 10 24	4 007371 056687	
26,0	12,0	5,3	10	04 0100 10 26	4 007371 056700	
28,0	13,0	6,6	11	04 0100 10 28	4 007371 060264	



Bratentopf, oval mit Gussdeckel, schwarz

oval french oven, with lid
cocotte ovale, avec couvercle
casseruola ovale, con coperchio
cacerola oval, con tapa
kookpan ovaal, met deksel

Ø cm	Höhe cm	Inhalt ltr.	Ø inch	Art.-Nr.	EAN	GP
33,0	13,0	7,0	13	04 0200 10 33	4 007371 057530	
35,0	14,0	8,9	14	04 0200 10 35	4 007371 057554	
40,0	16,0	12,5	16	04 0200 10 40	4 007371 057578	



Bauernpfanne mit hohem Glasdeckel, schwarz

braising pot, with glass lid
cocotte, avec couvercle en verre
casseruola, con coperchio in vetro
cacerola, con tapa vidrio
kookpan, met glasdeksel

Ø cm	Höhe cm	Inhalt ltr.	Ø inch	Art.-Nr.	EAN	GP
28,0	7,5	3,25	11	04 0255 10 28	4 007371 056724	



Gourmetpfanne mit Gussdeckel, schwarz

braising pot, with lid
cocotte, avec couvercle
casseruola, con coperchio
cacerola, con tapa
kookpan, met deksel

Ø cm	Höhe cm	Inhalt ltr.	Ø inch	Art.-Nr.	EAN	GP
28,0	7,5	3,9	11	04 1600 10 28	4 007371 060288	



Gourmetpfanne mit Glasdeckel, schwarz

braising pot, with glass lid
cocotte, avec couvercle en verre
casseruola, con coperchio in vetro
cacerola, con tapa vidrio
kookpan, met glasdeksel



Ø cm	Höhe cm	Inhalt ltr.	Ø inch	Art.-Nr.	EAN	GP
28,0	7,5	3,9	11	04 1700 10 28	4 007371 054065	



- für besonders schonendes & schmackhaftes Braten und Garen.
- Profi-Qualität
- optimale Hitzeverteilung ■ besonders energiesparend
- mit Plan-Boden für: Glaskeramik, Induktion, Halogen, Elektro, Gas

**Bratpfanne mit
Edelstahlgriff, schwarz**



fry pan with stainless steel handle
 poêle avec manche en acier inoxydable
 padella con manico in acciaio inox
 sartén con mango de acero inoxidable
 koekepan met edelstalen greep

cm	inch	Art.-Nr.	EAN	
24,0	9½	04 0300 10 24	4 007371 058896	
28,0	11	04 0300 10 28	4 007371 056748	



Bratreine, schwarz



roasting pan
 braisière
 brasiera
 placa asar
 braadslede

L / B / H cm	Inhalt ltr.	inch	Art.-Nr.	EAN	
43,0 x 25,0 x 7,0	4,7	17 x 10 x 3	04 0400 10 43	4 007371 059343	



**Grillpfanne mit 2 Griffen,
schwarz**

grill pan with 2 handles
 poêle pour grillades avec 2 manches
 padella per arrosti con 2 manichi
 sartén para rustidos con 2 mangos
 grillpan met 2 grepen



Ø cm	Ø inch	Art.-Nr.	EAN	
26,0	10	04 0759 10 26	4 007371 059367	

Grill-/Bratfläche: 25,0 cm



**Grillpfanne mit Griff,
schwarz**

grill pan with handle
 poêle pour grillades avec manche
 padella per arrosti con manico
 sartén para rustidos con mango
 grillpan met greep



L / B / H cm	inch	Art.-Nr.	EAN	
26,0 x 26,0 x 4,5	10 x 10 x 2	04 0780 10 26	4 007371 059374	

Grill-/Bratfläche: 23,0 cm



**Grillpfanne quadratisch,
schwarz**

grill pan, square
 poêle pour grillades, carrée
 padella per arrosti, rettangolare
 sartén para rustidos, cuadrado
 grillpan vierkant

L / B cm	inch	Art.-Nr.	EAN	
24,0 x 24,0 x 1,5	9½ x 9½ x ½	04 0753 10 24	4 007371 060967	

Grill-/Bratfläche: 22,0 x 22,0 cm
 Griff klappbar



GP = Produkt in farbigem Geschenkkarton



KE = auf Karte mit Euroloch



- für besonders schonendes & schmackhaftes Braten und Garen.
- Profi-Qualität
- optimale Hitzeverteilung ■ besonders energiesparend
- mit Plan-Boden für: Glaskeramik, Induktion, Halogen, Elektro, Gas



Paella-Pfanne mit Glasdeckel, schwarz

Ø cm	Höhe cm	Inhalt ltr.	Ø inch	Art.-Nr.	EAN	GP
34,0	5,0	3,0	13 1/8	04 0600 10 34	4 007371 061100	

paella pan, with glass lid
 poêle pour paella, avec couvercle en verre
 padella per paella, con coperchio in vetro
 paellera, con tapa vidrio
 paella-pan, met glasdeksel



Wok-Set mit Glasdeckel, inklusive Zubehör, schwarz

Ø cm	Höhe cm	Ø inch	Art.-Nr.	EAN	GP
36,0	9,5	14	04 1500 10 37	4 007371 054034	

(WOK-Wender und Chopsticks aus Naturholz, Abtropfgitter)

WOK set



KÜCHENPROFI »Premium« Serie in ausgezeichneter Profi-Qualität

WOK-Set mit Glasdeckel, Edelstahl-Design-Griffen, inklusive Zubehör, schwarz

Ø cm	Höhe cm	Ø inch	Art.-Nr.	EAN	GP
36,0	10,0	14	04 1000 10 36	4 007371 041621	

(WOK-Wender aus Naturholz, Abtropfgitter)

WOK set



Gourmet-Pfanne mit Glasdeckel und Edelstahl-Design-Griffen, schwarz

Ø cm	Höhe cm	Inhalt ltr.	Ø inch	Art.-Nr.	EAN	GP
28,0	7,5	3,9	11	04 2000 10 28	4 007371 042338	

braising pot, with glass lid
 cocotte, avec couvercle en verre
 casseruola, con coperchio in vetro
 cacerola, con tapa vidrio
 kookpan, met glasdeksel



- für besonders schonendes & schmackhaftes Braten und Garen.
- Profi-Qualität
- optimale Hitzeverteilung ■ besonders energiesparend
- mit Plan-Boden für: Glaskeramik, Induktion, Halogen, Elektro, Gas

Bratentopf, rund mit Gussdeckel, rot

round french oven, with lid
 cocotte ronde, avec couvercle
 casseruola rotonda, con coperchio
 cacerola redonda, con tapa
 kookpan rond, met deksel



Ø cm	Höhe cm	Inhalt ltr.	Ø inch	Art.-Nr.	EAN	GP
24,0	11,5	4,2	9½	04 0100 14 24	4 007371 056694	
26,0	12,0	5,3	10	04 0100 14 26	4 007371 056717	
28,0	13,0	6,6	11	04 0100 14 28	4 007371 060271	

Bratentopf, oval mit Gussdeckel, rot

oval french oven, with lid
 cocotte ovale, avec couvercle
 casseruola ovale, con coperchio
 cacerola oval, con tapa
 kookpan ovaal, met deksel



Ø cm	Höhe cm	Inhalt ltr.	Ø inch	Art.-Nr.	EAN	GP
33,0	13,0	7,0	13	04 0200 14 33	4 007371 057547	
35,0	14,0	8,9	14	04 0200 14 35	4 007371 057561	
40,0	16,0	12,5	16	04 0200 14 40	4 007371 057585	

Bauernpfanne mit hohem Glasdeckel, rot

braising pot, with glass lid
 cocotte, avec couvercle en verre
 casseruola, con coperchio in vetro
 cacerola, con tapa vidrio
 kookpan, met glasdeksel



Ø cm	Höhe cm	Inhalt ltr.	Ø inch	Art.-Nr.	EAN	GP
28,0	7,5	3,25	11	04 0255 14 28	4 007371 056731	

Gourmetpfanne mit Gussdeckel, rot

braising pot, with lid
 cocotte, avec couvercle
 casseruola, con coperchio
 cacerola, con tapa
 kookpan, met deksel



Ø cm	Höhe cm	Inhalt ltr.	Ø inch	Art.-Nr.	EAN	GP
28,0	7,5	3,9	11	04 1600 14 28	4 007371 060295	

Gourmetpfanne mit Glasdeckel, rot

braising pot, with glass lid
 cocotte, avec couvercle en verre
 casseruola, con coperchio in vetro
 cacerola, con tapa vidrio
 kookpan, met glasdeksel



Ø cm	Höhe cm	Inhalt ltr.	Ø inch	Art.-Nr.	EAN	GP
28,0	7,5	3,9	11	04 1700 14 28	4 007371 054072	



- für besonders schonendes & schmackhaftes Braten und Garen.
- Profi-Qualität
- optimale Hitzeverteilung ■ besonders energiesparend
- mit Plan-Boden für: Glaskeramik, Induktion, Halogen, Elektro, Gas



Bratpfanne mit Edelstahlgriff, rot

fry pan with stainless steel handle
poêle avec manche en acier inoxydable
padella con manico in acciaio inox
sartén con mango de acero inoxidable
koekepan met edelstalen greep

Ø cm	Ø inch	Art.-Nr.	EAN	GP
24,0	9½	04 0300 14 24	4 007371 058902	
28,0	11	04 0300 14 28	4 007371 056755	



Bratreine, rot

roasting pan
braisière
brasiera
placa asar
braadslede

L / B / H cm	Inhalt ltr.	inch	Art.-Nr.	EAN	GP
43,0 x 25,0 x 7,0	4,7	17 x 10 x 3	04 0400 14 43	4 007371 059350	

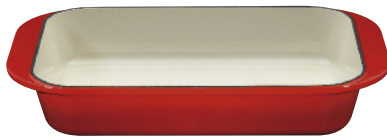

Grillpfanne mit Griff, rot

grill pan with handle
poêle pour grillades avec manche
padella per arrostiti con manico
sartén para rustidos con mango
grillpan met greep

L / B / H cm	inch	Art.-Nr.	EAN	GP
26,0 x 26,0 x 4,5	10 x 10 x 2	04 0780 14 26	4 007371 059381	

Grill-/Bratfläche: 23,0 cm



Wok-Set mit Glasdeckel, inklusive Zubehör, rot

(WOK-Wender und Chopsticks aus Naturholz, Abtropfgitter)

WOK set

Ø cm	Höhe cm	Ø inch	Art.-Nr.	EAN	GP
36,0	9,5	14	04 1500 14 37	4 007371 054041	



Paella-Pfanne mit Glasdeckel, rot

paella pan, with glass lid
poêle pour paella, avec couvercle en verre
padella per paella, con coperchio in vetro
paellera, con tapa vidrio
paella-pan, met glasdeksel

Ø cm	Höhe cm	Inhalt ltr.	Ø inch	Art.-Nr.	EAN	GP
34,0	5,0	3,0	13½	04 0600 14 34	4 007371 061117	





- ideal für Backofen, Mikrowelle, Kühl- oder Gefrierschrank
- temperaturbeständig von -18°C bis +250°C
- kratz- und schnittfest dank glasierter Oberfläche
- spülmaschinenfest



Mini-Töpfchen aus Keramik

ceramic mini casserole
 mini cocotte de céramique
 casseruola piccola di ceramica
 cacerola pequeña de cerámica
 mini pan van keramiek

	Ø cm	Höhe cm	Inhalt ltr.	Ø inch	Art.-Nr.	EAN	
●	10	5	0,2	4	04 5100 10 10	4 007371 060653	
●	10	5	0,2	4	04 5100 14 10	4 007371 060660	



Ofenfestes Hartporzellan

Burgund

Profi-Qualität bekannt aus der Gastronomie, jetzt auch für den Gebrauch zu Hause

Das elegante Design der Formen und das schlichte Weiß bereichern jede Küche und den gedeckten Tisch. Jedes Teil wird bei ca. 1400° C gebrannt und erhält dadurch eine einzigartige Qualität.

- hitzebeständig bis 280°C
- stoßfest und kantenstabil
- geschmacksneutral
- hygienisch einwandfrei

Hervorragend für Backofen, Mikrowelle und Tiefkühlschrank geeignet.

bis 280°C
hitzebeständig
Gastronomie
erprobt



- für Backofen (bis 280°C)
Mikrowelle, Kühlschrank und Gefrierschrank
- ideal zum Zubereiten, Servieren, Aufbewahren,
Warmhalten und Einfrieren



Bauernform, oval

deep baker
plat à four
pirofila
fuente para horno
ovenschaal

L/B/H cm	inch	Art.-Nr.	EAN
20,5 x 14,5 x 5,0	8 x 5½ x 2	07 5001 82 20	4 007371 050968
26,0 x 18,0 x 6,0	10 x 7 x 2½	07 5001 82 26	4 007371 049108
30,0 x 20,0 x 6,0	12 x 8 x 2½	07 5001 82 30	4 007371 046732
35,0 x 23,0 x 6,0	13½ x 9 x 2½	07 5001 82 35	4 007371 046749



Auflaufform, rechteckig

deep baker
moule à gratin
teglia forno
fuente
gratineerschaal

L/B/H cm	inch	Art.-Nr.	EAN
12,5 x 8,0 x 3,5	5 x 3 x 1½	07 5011 82 12	4 007371 055529

24 Stück im attraktiven Verkaufs-Display



Auflaufform, rechteckig

deep baker
moule à gratin
teglia forno
fuente
gratineerschaal

L/B/H cm	inch	Art.-Nr.	EAN
20,0 x 12,0 x 6,0	8 x 5 x 2½	07 5011 82 20	4 007371 050951
30,0 x 21,0 x 6,0	12 x 8½ x 2½	07 5011 82 30	4 007371 046756
35,0 x 24,0 x 6,0	13½ x 9½ x 2½	07 5011 82 35	4 007371 046763



Lasagneform, extra hoch

deep baker
moule à gratin
teglia forno
fuente
gratineerschaal

L/B/H cm	inch	Art.-Nr.	EAN
24,0 x 15,0 x 6,5	9.5 x 6 x 2.5	07 5021 82 24	4 007371 060301
33,0 x 25,0 x 7,0	13 x 10 x 3	07 5021 82 33	4 007371 047838
38,0 x 25,0 x 7,0	15 x 10 x 3	07 5021 82 38	4 007371 047845



Schlemmerform

deep baker
moule à gratin
teglia forno
fuente
gratineerschaal

L/B/H cm	inch	Art.-Nr.	EAN
31,0 x 21,0 x 5,5	12 x 8 x 2	07 5031 82 31	4 007371 049115
35,5 x 25,5 x 5,5	14 x 10 x 2	07 5031 82 35	4 007371 048682
41,0 x 30,5 x 5,5	16 x 12 x 2	07 5031 82 42	4 007371 048699



Mikrowellenform

microwave dish
moule à microonde
pirofila per microonde
fuente para microondas
magnetronschaal

L/B/H cm	inch	Art.-Nr.	EAN
20,0 x 20,0 x 4,5	7¾ x 7¾ x 2	07 5151 82 20	4 007371 050630



- für Backofen (bis 280°C)
Mikrowelle, Kühlschrank und Gefrierschrank
- ideal zum Zubereiten, Servieren, Aufbewahren,
Warmhalten und Einfrieren



Tartelettförmchen

round flan dish
moule à tartelette
stampo torta
molde de tarta
taartvorm

Ø cm	Höhe cm	Ø inch	Art.-Nr.	EAN
12,0	3,0	5	07 5041 82 12	4 007371 049009

24 Stück im attraktiven Verkaufs-Display



Tortenform

round flan dish
moule à tarte
stampo torta
molde de tarta
taartvorm

Ø cm	Höhe cm	Ø inch	Art.-Nr.	EAN
20,0	3,5	8	07 5041 82 20	4 007371 057875
27,0	3,5	10½	07 5041 82 28	4 007371 048637
29,5	3,5	11½	07 5041 82 30	4 007371 048644
33,0	3,5	13	07 5041 82 33	4 007371 057882



Ragoutschälchen

ramekin
ramequin
ramequin
ramekin
ragoutschaaltje

Ø cm	Höhe cm	Ø inch	Art.-Nr.	EAN
9,0	4,0	3½	07 5061 82 09	4 007371 048996

24 Stück im attraktiven Verkaufs-Display



11,0	5,5	4½	07 5061 82 11	4 007371 050944
------	-----	----	----------------------	-----------------

12 Stück im attraktiven Verkaufs-Display

Puddingförmchen

pudding bowl
moule à clafoutis
stampo budino
ramekin
puddingvorm

Ø cm	Höhe cm	Ø inch	Art.-Nr.	EAN
11,0	4,0	4½	07 5071 82 11	4 007371 049016

24 Stück im attraktiven Verkaufs-Display



Eierbecher

egg cup
coquetier
portauovo
huevera
eierdopje

Ø cm	Höhe cm	Ø inch	Art.-Nr.	EAN
5,0	7,0	2	07 5081 82 00	4 007371 049054

24 Stück im attraktiven Verkaufs-Display



Eierbecher, 2er Set

egg cup
coquetier
portauovo
huevera
eierdopje

Ø cm	Ø inch	Art.-Nr.	EAN
10,5	4	07 5082 82 02	4 007371 053167



GP = Produkt in farbigem Geschenkkarton



KE = auf Karte mit Euroloch

- für Backofen (bis 280°C)
Mikrowelle, Kühlschrank und Gefrierschrank
- ideal zum Zubereiten, Servieren, Aufbewahren,
Warmhalten und Einfrieren



Ragoutschälchen »Classic«

ramekin
ramequin
ramequin
ramekin
ragoutschaaltje



Ø cm	Höhe cm	Ø inch	Art.-Nr.	EAN
9,0	4,0	3½	07 5404 82 09	4 007371 048989

24 Stück im attraktiven Verkaufs-Display

Crème Brûlée-Schale »Classic«

Crème Brûlée dish
moule à Crème Brûlée
scodella Crème Brûlée
bol para crema catalana
Crème Brûlée schaalte



Ø cm	Höhe cm	Ø inch	Art.-Nr.	EAN
15,0	2,5	6	07 2050 82 00	4 007371 051132

Crème Brûlée-Schale

Crème Brûlée dish
moule à Crème Brûlée
scodella Crème Brûlée
bol para crema catalana
Crème Brûlée schaalte



Ø cm	Höhe cm	Ø inch	Art.-Nr.	EAN
15,0	2,5	6	07 5091 82 15	4 007371 049061

Mini Terrinenformen, 3er Set

mini tureen dish
mini terrine
mini terrina
molde para paté
mini terrine vorm



Ø cm	Höhe cm	Ø inch	Art.-Nr.	EAN
10,0	3,5	3½	07 5010 82 03	4 007371 057899

Hase, Fisch und Ente - Inhalt je 100ml

Zitronenpresse

lemon squeezer
presse-agrume
spremiagrumi
prensa limones
citruspers



L / B / H cm	inch	Art.-Nr.	EAN
20,0 x 11,0 x 5,5	8 x 4 x 2	07 6060 82 00	4 007371 054195

Pastetenform

pie dish
terraine à pâté
terrina
terrina
terraine



L / B / H cm	Inhalt ltr.	inch	Art.-Nr.	EAN
19,0 x 14,5 x 8,5	1,0	7½ x 6 x 3½	07 4303 82 10	4 007371 060615
24,0 x 17,5 x 9,0	1,6	9½ x 7 x 3½	07 4303 82 16	4 007371 060622



die farbenfrohe Servierkollektion

aus ofenfester Keramik, französische Produktion



- für Backofen (bis 280°C)
Mikrowelle und Kühlschrank
- ideal zum Zubereiten, Servieren und Aufbewahren



**Auflaufform,
mandarine/orange**

deep baker
plat à pâté
teglia forno
fuente
gratineerschaal

L/B/H cm	inch	Art.-Nr.	EAN
33,0 x 22,5 x 6,0	13 x 9 x 2½	07 0500 40 33	4 007371 054645



**Auflaufform,
cremeweiß/anthrazit**

deep baker
plat à pâté
teglia forno
fuente
gratineerschaal

L/B/H cm	inch	Art.-Nr.	EAN
33,0 x 22,5 x 6,0	13 x 9 x 2½	07 0500 41 33	4 007371 054652



**Auflaufform,
kiwi/mirabelle**

deep baker
plat à pâté
teglia forno
fuente
gratineerschaal

L/B/H cm	inch	Art.-Nr.	EAN
33,0 x 22,5 x 6,0	13 x 9 x 2½	07 0500 42 33	4 007371 054669



**Auflaufform,
meerblau/creme**

deep baker
plat à pâté
teglia forno
fuente
gratineerschaal

L/B/H cm	inch	Art.-Nr.	EAN
33,0 x 22,5 x 6,0	13 x 9 x 2½	07 0500 43 33	4 007371 054676



**Auflaufform,
schwarz/rot**

deep baker
plat à pâté
teglia forno
fuente
gratineerschaal

L/B/H cm	inch	Art.-Nr.	EAN
33,0 x 22,5 x 6,0	13 x 9 x 2½	07 0500 44 33	4 007371 054683



**Auflaufform,
pflaume/malve**

deep baker
plat à pâté
teglia forno
fuente
gratineerschaal

L/B/H cm	inch	Art.-Nr.	EAN
33,0 x 22,5 x 6,0	13 x 9 x 2½	07 0500 45 33	4 007371 054690



**Lasagneform,
mandarine/orange**

deep baker
moule à lasagne
teglia forno
fuente
gratineerschaal

L/B/H cm	inch	Art.-Nr.	EAN
28,0 x 19,5 x 6,5	11 x 7½ x 2½	07 0600 40 28	4 007371 055123



**Lasagneform,
cremeweiß/anthrazit**

deep baker
moule à lasagne
teglia forno
fuente
gratineerschaal

L/B/H cm	inch	Art.-Nr.	EAN
28,0 x 19,5 x 6,5	11 x 7½ x 2½	07 0600 41 28	4 007371 055130



**Lasagneform,
kiwi/mirabelle**

deep baker
moule à lasagne
teglia forno
fuente
gratineerschaal

L/B/H cm	inch	Art.-Nr.	EAN
28,0 x 19,5 x 6,5	11 x 7½ x 2½	07 0600 42 28	4 007371 055147



**Lasagneform,
meerblau/creme**

deep baker
moule à lasagne
teglia forno
fuente
gratineerschaal

L/B/H cm	inch	Art.-Nr.	EAN
28,0 x 19,5 x 6,5	11 x 7½ x 2½	07 0600 43 28	4 007371 055154



**Lasagneform,
schwarz/rot**

deep baker
moule à lasagne
teglia forno
fuente
gratineerschaal

L/B/H cm	inch	Art.-Nr.	EAN
28,0 x 19,5 x 6,5	11 x 7½ x 2½	07 0600 44 28	4 007371 055161



**Lasagneform,
pflaume/malve**

deep baker
moule à lasagne
teglia forno
fuente
gratineerschaal

L/B/H cm	inch	Art.-Nr.	EAN
28,0 x 19,5 x 6,5	11 x 7½ x 2½	07 0600 45 28	4 007371 055178

die farbenfrohe Servierkollektion

aus ofenfester Keramik, französische Produktion

- für Backofen (bis 280°C)
Mikrowelle und Kühlschrank
- ideal zum Zubereiten, Servieren und Aufbewahren



**Ragoutschälchen,
4er Set
mandarine/orange**

ramekin
ramequin
ramequin
ramekin
ragoutschaaltje

Ø cm	Höhe cm	Ø inch	Art.-Nr.	EAN
10,0	4,5	4	07 0700 40 04	4 007371 055185



**Ragoutschälchen,
4er Set
cremeweiß/anthrazit**

ramekin
ramequin
ramequin
ramekin
ragoutschaaltje

Ø cm	Höhe cm	Ø inch	Art.-Nr.	EAN
10,0	4,5	4	07 0700 41 04	4 007371 055192



**Ragoutschälchen,
4er Set
kiwi/mirabelle**

ramekin
ramequin
ramequin
ramekin
ragoutschaaltje

Ø cm	Höhe cm	Ø inch	Art.-Nr.	EAN
10,0	4,5	4	07 0700 42 04	4 007371 055208



**Ragoutschälchen,
4er Set
meerblau/creme**

ramekin
ramequin
ramequin
ramekin
ragoutschaaltje

Ø cm	Höhe cm	Ø inch	Art.-Nr.	EAN
10,0	4,5	4	07 0700 43 04	4 007371 055215



**Ragoutschälchen,
4er Set
schwarz/rot**

ramekin
ramequin
ramequin
ramekin
ragoutschaaltje

Ø cm	Höhe cm	Ø inch	Art.-Nr.	EAN
10,0	4,5	4	07 0700 44 04	4 007371 055222



**Ragoutschälchen,
4er Set
pflaume/malve**

ramekin
ramequin
ramequin
ramekin
ragoutschaaltje

Ø cm	Höhe cm	Ø inch	Art.-Nr.	EAN
10,0	4,5	4	07 0700 45 04	4 007371 055239

Tortenform, mandarine/orange

round flan dish
moule à tarte
stampo torta
molde de tarta
taartvorm



Ø cm	Höhe cm	Ø inch	Art.-Nr.	EAN
28,0	4,0	11	07 0800 40 28	4 007371 055246

Tortenform, cremeweiß/anthrazit

round flan dish
moule à tarte
stampo torta
molde de tarta
taartvorm



Ø cm	Höhe cm	Ø inch	Art.-Nr.	EAN
28,0	4,0	11	07 0800 41 28	4 007371 055253

Tortenform, kiwi/mirabelle

round flan dish
moule à tarte
stampo torta
molde de tarta
taartvorm



Ø cm	Höhe cm	Ø inch	Art.-Nr.	EAN
28,0	4,0	11	07 0800 42 28	4 007371 055260

Tortenform, meerblau/creme

round flan dish
moule à tarte
stampo torta
molde de tarta
taartvorm



Ø cm	Höhe cm	Ø inch	Art.-Nr.	EAN
28,0	4,0	11	07 0800 43 28	4 007371 055277

Tortenform, schwarz/rot

round flan dish
moule à tarte
stampo torta
molde de tarta
taartvorm



Ø cm	Höhe cm	Ø inch	Art.-Nr.	EAN
28,0	4,0	11	07 0800 44 28	4 007371 055284

Tortenform, pflaume/malve

round flan dish
moule à tarte
stampo torta
molde de tarta
taartvorm



Ø cm	Höhe cm	Ø inch	Art.-Nr.	EAN
28,0	4,0	11	07 0800 45 28	4 007371 055291



Alles für

italienische Pizza und Pasta

Die original italienischen Nudelmachines von Marcato gehören zu den unentbehrlichen Helfern für perfekte Pasta.

Mit dem praktischen Zubehör gelangen Ihnen mühelos kulinarische Köstlichkeiten für einen unverwechselbaren Genuss bei Ihnen zu Hause.





**Nudelmaschine
 »Ampia«
 mit 3 Aluminium-Walzen**

pasta machine
 machine à nouilles
 macchina per pasta
 máquina pastas
 pastamachine

Art.-Nr. EAN 
08 0150 12 15 

L/B/H cm inch
 20,0 x 17,0 x 13,0 8 x 6½ x 5

nicht kompatibel mit den Marcato-Vorsätzen
 geeignet für Lasagne, Fettuccine & Tagliolini
 geeignet für Motor



**Nudelmaschine
 »Atlas 150«
 mit 3 Aluminium-Walzen**

pasta machine
 machine à nouilles
 macchina per pasta
 máquina pastas
 pastamachine

Art.-Nr. EAN 
08 0151 12 00 

L/B/H cm inch
 19,0 x 12,4 x 13,0 7½ x 5 x 5

geeignet für Lasagne, Fettuccine & Tagliolini
 geeignet für Motor



**Nudelmaschine
 »Multipast«
 mit 6 Aluminium-Walzen**

pasta machine
 machine à nouilles
 macchina per pasta
 máquina pastas
 pastamachine

Art.-Nr. EAN 
08 0153 12 00 

Set besteht aus:
 - Nudelmaschine ATLAS, geeignet für
 Lasagne, Fettuccine & Tagliolini
 - Aufsätze für Raviolini, Spaghetti und
 Reginette sowie einem Teigrädchen
 geeignet für Motor



**Nudelmaschine
 »Atlasmotor«
 mit 3 Aluminium-Walzen
 und Motor**

pasta machine
 machine à nouilles
 macchina per pasta
 máquina pastas
 pastamachine

Art.-Nr. EAN 
08 0155 12 00 

geeignet für
 Lasagne, Fettuccine & Tagliolini
 Set besteht aus:
 - Nudelmaschine ATLAS, geeignet für
 Lasagne, Fettuccine & Tagliolini
 - Motor, 230V ~ 50Hz, 100 Watt, Gehäuse aus
 Kunststoff



**Profi-Nudelmaschine
 »Ristorantica«**

prof. pasta machine
 machine à nouilles professionnelle
 macchina per pasta professionale
 máquina pastas profesional
 professioneele pastamachine

Art.-Nr. EAN 
08 0185 00 00 

L/B/H cm inch
 35,0 x 25,0 x 29,0 13¾ x 10 x 11½

Aluminium eloxiert
 Grundausstattung: Maschine, 2 Aufsätze
 (Lasagne, Fettuccine), 3 Schablonen (Spaghetti,
 Rigatoni, Maccheroni), Teigschneider
 technische Daten: 220-240 Volt / 700 Watt



**Nudelmaschine
»Atlas 150«**

pasta machine
machine à nouilles
macchina per pasta
máquina pastas
pastmaschine

schwarz

Art.-Nr.	EAN	
08 0163 10 00	8 000011 002491	

L/B/H cm	inch
19,0 x 12,4 x 13,0	8 x 6½ x 5

geeignet für Lasagne, Fettuccine & Tagliolini
geeignet für Motor



**Nudelmaschine
»Atlas 150«**

pasta machine
machine à nouilles
macchina per pasta
máquina pastas
pastmaschine

rot

Art.-Nr.	EAN	
08 0163 14 00	8 000011 002477	

L/B/H cm	inch
19,0 x 12,4 x 13,0	7½ x 5 x 5

geeignet für Lasagne, Fettuccine & Tagliolini
geeignet für Motor



**Nudelmaschine
»Atlas 150«**

pasta machine
machine à nouilles
macchina per pasta
máquina pastas
pastmaschine

silber

Art.-Nr.	EAN	
08 0163 24 00	8 000011 002606	

L/B/H cm	inch
19,0 x 12,4 x 13,0	7½ x 5 x 5

geeignet für Lasagne, Fettuccine & Tagliolini
geeignet für Motor



GP = Produkt in farbigem Geschenkkarton



KE = auf Karte mit Euroloch



**Aufsätze / Zubehör
für die Nudelmaschine »ATLAS«
Walzen aus eloxiertem Aluminium**



**Motor für
Nudelmaschine**

motor for pasta machine
moteur pour machine à nouilles
motore per macchina per pasta
motor para máquina pastas
motor voor pastamachine

L/B/H cm	inch	Art.-Nr.	EAN	
18,0 x 14,0 x 11,0	7 x 5½ x 4¼	08 0150 00 01	8 0000 11 0020 33	

Technische Daten: Betriebsspannung: 230V ~ 50Hz,
Motorleistung: 100 Watt

Gehäuse aus Kunststoff



Lasagnette-Aufsatz

attachment for lasagnette
adaptateur pour pâtes lasagnette
accessorio per lasagnette
accesorio para lasagnette
opzet voor lasagnette

L/B/H cm	inch	Art.-Nr.	EAN	
18,0 x 7,0 x 4,0	7 x 2½ x 1½	08 0150 00 03	8 0000 11 0020 26	

Breite der Pasta 11 mm
geeignet für Motor



Mafaldine-Aufsatz

attachment for mafaldine
adaptateur pour pâtes mafaldine
accessorio per mafaldine
accesorio para mafaldine
opzet voor mafaldine

L/B/H cm	inch	Art.-Nr.	EAN	
18,0 x 7,0 x 5,0	7 x 2½ x 2	08 0150 00 04	8 0000 11 0004 28	

Breite der Pasta 8 mm



Pappardelle-Aufsatz

attachment for pappardelle
adaptateur pour pâtes paparnelle
accessorio per paparnelle
accesorio para pappardelle
opzet voor pappardelle

L/B/H cm	inch	Art.-Nr.	EAN	
18,0 x 7,0 x 5,0	7 x 2½ x 2	08 0150 00 05	8 0000 11 0001 38	

Breite der Pasta 50 mm



Raviolini-Aufsatz

attachment for raviolini
adaptateur pour pâtes raviolini
accessorio per raviolini
accesorio para raviolini
opzet voor raviolini

L/B/H cm	inch	Art.-Nr.	EAN	
18,0 x 11,0 x 10,0	7 x 4¼ x 4	08 0150 00 06	8 0000 11 0021 49	

Breite der Pasta 30 x 30 mm
mit Trichter für die Füllung



Reginette-Aufsatz

attachment for reginette
adaptateur pour pâtes reginette
accessorio per reginette
accesorio para reginette
opzet voor reginette

L/B/H cm	inch	Art.-Nr.	EAN	
18,0 x 7,0 x 5,0	7 x 2½ x 2	08 0150 00 07	8 0000 11 0001 21	

Breite der Pasta 12 mm



Chitarra-Aufsatz

attachment for chitarra
adaptateur pour pâtes chitarra
accessorio per chitarra
accesorio para chitarra
opzet voor chitarra

L/B/H cm	inch	Art.-Nr.	EAN	
18,0 x 7,0 x 5,0	7 x 2½ x 2	08 0150 00 08	8 0000 11 0001 07	

Breite der Pasta 2 mm
für Spaghetti alla Chitarra
geeignet für Motor





**Aufsätze / Zubehör
für die Nudelmaschine »ATLAS«
Walzen aus eloxiertem Aluminium**



Capellini-Aufsatz

attachment for capellini
adaptateur pour pâtes capellini
accessorio per capellini
acessorio para capellini
opzegt voor capellini

L/B/H cm	inch	Art.-Nr.	EAN	GP
18,0 x 7,0 x 4,0	7 x 2½ x 1½	08 0150 00 09	8 000011 000091	

Breite der Pasta 1 mm
geeignet für Motor



Spaghetti-Aufsatz

attachment for spaghetti
adaptateur pour spaghetti
accessorio per spaghetti
acessorio para spaghetti
spaghetti opzet

L/B/H cm	inch	Art.-Nr.	EAN	GP
18,0 x 7,0 x 5,0	7 x 2½ x 2	08 0150 00 10	8 000011 000084	

Breite der Pasta 2 mm
für Spaghetti
geeignet für Motor 08 0150 00 01



Ravioli-Aufsatz

attachment for ravioli
adaptateur pour raviolis
accessorio per ravioli
acessorio para ravioli
ravioli opzet

L/B/H cm	inch	Art.-Nr.	EAN	GP
33,0 x 22,5 x 6,0	13 x 9 x 2½	07 0500 40 33	8 000011 002125	



**Nudeltrockner
»Tacapasta«**

pasta drying stand
sècheir à nouilles
essiccatoio per pasta
secadero para pastas
pastadroger

L/B/H cm	inch	Art.-Nr.	EAN	GP
33,0 x 22,5 x 6,0	13 x 9 x 2½	07 0500 40 33	8 000011 003009	



**Nudelmaschine
»Compack«**

pasta machine
machine à nouilles
macchina per pasta
máquina pastas
pastmaschine

L/B/H cm	inch	Art.-Nr.	EAN	GP
19,0 x 12,5 x 13,0	7½ x 5 x 5	08 0157 12 00	4 007371 048880	

geeignet für Lasagne, Fettuccine & Tagliolini



**Nudelmaschine
»Compack«**

pasta machine
machine à nouilles
macchina per pasta
máquina pastas
pastmaschine

L/B/H cm	inch	Art.-Nr.	EAN	GP
19,0 x 12,5 x 13,0	7½ x 5 x 5	08 0157 14 00	4 007371 059299	

geeignet für Lasagne, Fettuccine & Tagliolini



Pasta-Zubehör

Edelstahl rostfrei / stainless steel

Raviolibrett

ravioli mould
planche à raviolis
accessorio raviolatore
aparato antepusto ravioli
raviolivorm met roller





L/B cm	inch	Art.-Nr.	EAN	
37,5 x 12,0	14¾ x 4¾	08 0290 30 12	4 007371 057011	

aus Aluminium, inklusive Holzrolle, für 12 Ravioli

Ravioli-Rad

ravioli cutter
roulette à raviolis
tagliaravioli
corta ravioli
ravioli-snijder





Länge cm	inch	Art.-Nr.	EAN	
18,0	7	08 0350 28 00	4 007371 042796	

Ravioli-Former, rund

ravioli mould
moule à raviolis
forma per ravioli
molde para ravioli
ravioli-vormer





Ø cm	Ø inch	Art.-Nr.	EAN	
10,0	4	08 0355 28 00	4 007371 045612	
12,0	4½	08 0360 28 00	4 007371 042932	

Ravioliausstecher

ravioli stamp
emporte pièce pour raviolis
stampa per ravioli
cortador de ravioli
ravioli-steekvorm





Ø cm	Länge cm	Ø inch	Art.-Nr.	EAN	
6,5	12,5	2½	08 0371 28 00	4 007371 048651	

Spaghetti-Maß »Classic«

spaghetti measure
mesure à spaghetti
misura spaghetti
medidor spaghetti
spaghettimaat



L/B cm	inch	Art.-Nr.	EAN	
18,0 x 6,0	7 x 2½	10 3450 28 00	4 007371 035279	

für 1 – 4 Portionen

Pasta-Zubehör

Edelstahl rostfrei / stainless steel

Pasta & Pizza





Spätzle-ASS

spaetzle lid
couvercle à spaetzle
coperchio gnocchetti
tapa formapastas
spätzle-deksel

Ø cm	Ø inch	Art.-Nr.	EAN
27,0	10½	08 0816 28 27	4 007371 039840

für alle Töpfe von Ø 20 bis 28 cm, inklusive Teigschaber







Spätzlereibe

spaetzle maker
couvercle à spaetzle
coperchio gnocchetti
tapa formapasta
spätzle deksel

L/B/H cm	inch	Art.-Nr.	EAN
34,5 x 15,0 x 3,5	13½ x 6 x 1½	08 0818 28 00	4 007371 060080

Reibfläche 14 x 10 cm
für alle Töpfe von Ø 20 bis 28 cm, inklusive Teigschaber
hitzebeständige Griffe





Spätzle-Hobel

spaetzle plane
râpe à spaetzle
macchina gnocchetti inox
dispositivo-formapastas
spätzle-schaaf

L/B cm	inch	Art.-Nr.	EAN
31,0 x 11,0	12 x 4½	10 0231 28 00	4 007371 027991



Schaumlöffel

skimmer
écumoire
schiumarola
espumadera
schuimspaan

L cm	Ø cm Kelle	inch	Art.-Nr.	EAN
41,0	14	16 x 5½	11 0548 28 00	4 007371 057370



Kartoffel-/Spätzlepresse

potato / spaetzle press
presse purée / spaetzle
schiacciapate / -gnocchetti
prensa patatas /pasta fresca
puree- /spätzlepers

Ø cm	Länge cm	Ø inch	Art.-Nr.	EAN
8,0	37,0	3	13 1056 28 00	4 007371 041409



**Kartoffel-/Spätzlepresse
»Spätzleboy«**

potato / spaetzle press
presse purée / spaetzle
schiacciapate / -gnocchetti
prensa patatas /pasta fresca
puree- /spätzlepers

Ø cm	Länge cm	Ø inch	Art.-Nr.	EAN
9,0	42,0	3½	13 1075 30 00	4 007371 056359

Aluminium-Guss
auch für Spaghetti-Eis geeignet

GP = Produkt in farbigem Geschenkkarton

KE = auf Karte mit Euroloch

Alles für

Pizza

Steinofenpizza wie vom Lieblings-Italiener gelingt jetzt auch zu Hause. Die hochhitzebeständigen Pizza- und Grillsteine garantieren knusprigen Boden. Auch die Zubereitung anderer Spezialitäten im Backofen oder auf dem Grill wird zum Kinderspiel.



Pizzasteine und Zubehör



Pizza-Stein, mit Untersatz

pizza stone
pierre à pizza
pietra per pizza
base para hornear pizza
pizzasteen

L/B cm	inch	Art.-Nr.	EAN
38,0 x 35,5	15 x 14	10 8600 00 00	4 007371 049368

aus Cordierit-Material
ideal für die Zubereitung knuspriger Steinofenpizza



Pizza-Stein, mit Untersatz

pizza stone
pierre à pizza
pietra per pizza
base para hornear pizza
pizzasteen

Ø cm	Ø inch	Art.-Nr.	EAN
30,0	12	10 8610 00 30	4 007371 055741

aus Cordierit-Material
ideal für die Zubereitung knuspriger Steinofenpizza



Pizza-Stein »Profi«

pizza stone
pierre à pizza
pietra per pizza
base para hornear pizza
pizzasteen

L/B cm	inch	Art.-Nr.	EAN
35,0 x 40,0	14 x 16	10 8615 00 40	4 007371 055758

aus Cordierit-Material
sehr hohe Hitzebeständigkeit, daher ideal für den Einsatz im Backofen oder auf dem Grill
ideal für die Zubereitung knuspriger Steinofenpizza



Flammkuchenbrett

tarte flambée paddle
pelle à tarte flambée
paletta per Flammkuchen
pala para tarte flambée
tarte flambée schep

L/B cm	inch	Art.-Nr.	EAN
52,0 x 32,0	20½ x 12½	10 8660 10 00	4 007371 059411

Buchenholz, natur



Pizza-Schieber

pizza paddle
pelle à pizza
paletta per pizza
pala para pizza
pizzaschep

L/B cm	inch	Art.-Nr.	EAN
45,0 x 29,5	18 x 11½	10 8650 10 00	4 007371 049351

Holz, natur



Pizzaschneider

pizza cutter
roulette à pizza
rotella tagliapizza
cortador pizzas
pizza snijder

L/B cm	inch	Art.-Nr.	EAN
10,0 x 11,0	4 x 4½	08 0497 00 00	4 007371 055383

12 Stück im attraktiven Verkaufs-Display,
farblich sortiert



Pâtissier

Das Herstellen süßer Naschereien wie Popcakes oder Pralinen wird mit den praktischen Komplett-Sets zum Kinderspiel. Die beiliegenden Rezepthefte geben auch Anregungen für herzhaftes Häppchen und Snacks.

Backen

Ob Plätzchenausstecher, Keksstempel für Ostern oder Weihnachten, praktische Tortenringe oder Kuchengitter sowie Tortenformen mit Hebeboden – KÜCHENPROFI bietet eine interessante Produktpalette, die das Herz der Kuchenbäcker höher schlagen lässt.



Pâtissier

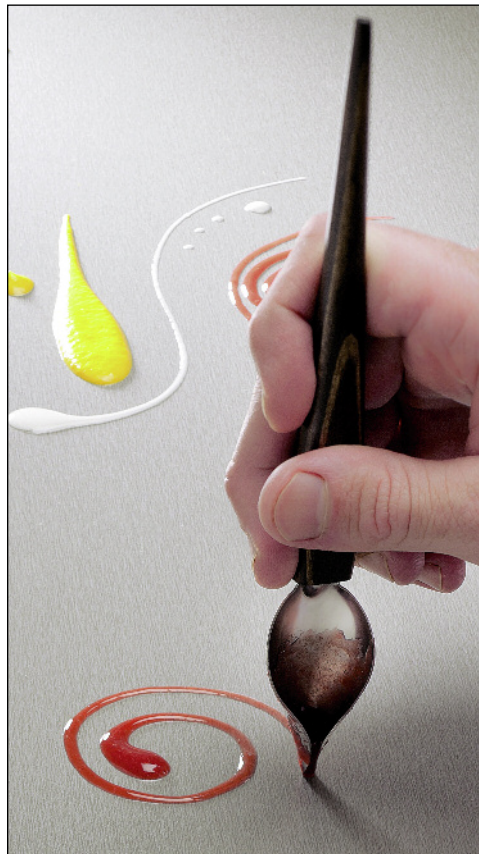

Anleitung:

Aus einem kleinen Behälter eine kleine Menge Soße in den Dekorierlöffel nehmen. Die Spitze des Löffels aufrecht auf den Teller setzen, dann mit dieser über das Porzellan gleiten. Ideal für Unterschriften oder Dekorationen z.B. mit: Salziger Soße, Tomatensoße, Schokoladensoße, Karamellsoße

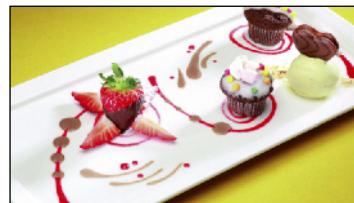

**Dekorierlöffel,
2er Set**

garnishing spoon
cuillère à décorer
cuchiao per decorare
cuchara decoradora
decoreerlepel



Länge cm	inch	Art.-Nr.	EAN	GP
19,0 + 23,0	7½ + 9	08 0501 25 02	4 007371 057240	

**Dekorierlöffel,
2er Set**

garnishing spoon
cuillère à décorer
cuchiao per decorare
cuchara decoradora
decoreerlepel



Länge cm	inch	Art.-Nr.	EAN	GP
19,0 + 23,0	7½ + 9	08 0501 28 02	4 007371 057257	

Stilvolle Zubereitung Backen / Dekorieren



Dekorier-Set, 7-teilig

decorating set
ensemble à decorer
set per decorare
set para decorar
decoratieset

Art.-Nr. EAN

08 0502 28 00



Das Set enthält: 4 Dekorier-Ringe aus Edelstahl (Ø 9 cm), 2 Dekorier-Löffel aus Edelstahl mit Silikon Griff (klein: 19 cm, groß: 23 cm), 1 Auslöser, Rezeptbuch



Rührlöffel-Set mit Thermometer, 3-teilig

pastry spoon and spatula
with Thermometer
râcloir et cuillère à pâte
avec thermometre
lecca et cucchiaio piatti
con termometro
espátula e cuchara masa
con termómetro
deegschrapper en -lepel
met thermometer

Art.-Nr. EAN

08 0503 55 00



Das Set enthält: 1 Rührlöffel (26,5 cm), 1 Schaber (26 cm), 1 digitales Thermometer (30 cm, -20°C – 240°C), 1 Batterie (LR44), Bedienungsanleitung

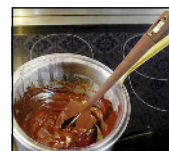

Exakte Temperaturkontrolle direkt beim Rühren.



Fondant-Trichter-Set, mit 3 Tüllen

confectionery funnel set
entonnoir doseur
imbuto colare
embudo dosificador
suikergiet trechter

Ø cm Ø inch
14,0 5½

Art.-Nr. EAN

08 0504 66 00



Das Set enthält: Trichter mit abnehmbarem Hebel (Inhalt 500 ml), 3 Tüllen und 1 Verschluss, Standfuß, Rezeptbuch



Spritzbeutel-Set, mit 9 Tüllen

icing set
poche à douille
tasca da pasticceria
manga pastelera
spuitzak

cm inch
33,0 13

Art.-Nr. EAN

08 0505 55 00



Das Set enthält: 1 Spritzbeutel aus Silikon, 1 Ständer, 9 Tüllen mit Auslaufstopp, 1 Adapter für leichtes Wechseln der Tüllen, 2 Verschlussringe, 1 Schieber, Rezeptbuch

Fassungsvermögen Spritzbeutel: max. 1 ltr



Mini-Tartelettes-Set, 3-teilig

mini tartlets set
ensemble de tartelettes mini
set per mini-tartelettes
set para mini-tartelettes
Mini-tarteletteset

L/B cm inch
30,0 x 18,0 11½ x 7

Art.-Nr. EAN

08 0506 55 00



Das Set enthält: 3 Silikonbackmatten (rund, eckig, oval), 3 Teigausstecher, 6 Einweg-Spritzbeutel inklusive 5 Tüllen und Adapter für leichtes Wechseln der Tüllen, Rezeptbuch



GP = Produkt in farbigem Geschenkkarton



KE = auf Karte mit Euroloch

Stilvolle Zubereitung Backen / Dekorieren



Tartelettes-Set, 3-teilig

tartlets set
ensemble de tartelettes
set per tartelettes
set para tartelettes
tarteletteset

L/B cm	inch	Art.-Nr.	EAN	
36,0 x 23,0	14 x 9	08 0507 55 00	4 007371 058179	

Das Set enthält: 2 Silikonbackmatten (8er: Ø 8 cm, 6er: Ø 11 cm), 1 Teigausstecher, Rezeptbuch

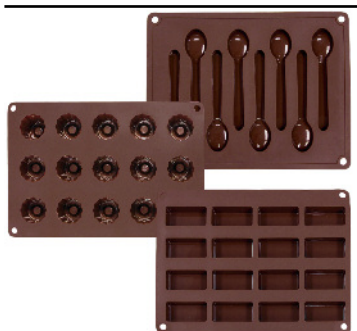

Gourmet-Set, 3-teilig

gourmet set
ensemble de gourmet
set per gourmet
set para gourmet
gourmet set

Art.-Nr.	EAN	
08 0508 55 00	4 007371 058186	

Das Set enthält: 1 Silikonbackmatte für Schokoladen- oder Gebäcklöffel (23,0 x 18,0 x 0,8 cm), 1 Silikonbackmatte für Cannelés (29,7 x 17,5 x 3,5 cm), 1 Silikonbackmatte für Mini-Financiers (29,7 x 17,5 x 1 cm), Rezeptbuch



Pralinen-Set, 7-teilig

chocolate set
ensemble à chocolats
set per praline
set para praliné
pralineset

L/B cm	inch	Art.-Nr.	EAN	
21,5 x 10,5	8½ x 4	08 0509 55 00	4 007371 058193	

Das Set enthält: 4 Silikonbackmatten (Herz, rund, Halbmond, quadratisch), 1 Abtropfgitter, Winkelpalette, 1 Pinsel, Rezeptbuch



Popcake-Set »Mini«

cake pop set »Mini«
ensemble de Popcake mini
set per mini-Popcake
set para mini-Popcake
Mini-Popcakeset

L/B/Ø cm	inch	Art.-Nr.	EAN	
23,0 x 11,5 x 3	9 x 2½ x 1	08 0510 55 00	4 007371 058209	

Das Set enthält: 1 Silikonbackmatte, 1 Deckel, 30 Papier-Stäbchen, Rezeptbuch

Popcake Stiele	Art.-Nr.	EAN	
60 Stück (Länge 12 cm)	08 0510 00 12	4 007371 059909	



Popcake-Set »Classic«

cake pop set „Classic“
ensemble de Popcake Classic
set per Popcake Classic
set para Popcake Classic
Popcakeset Classic

L/B/Ø cm	inch	Art.-Nr.	EAN	
30,0 x 11,5 x 4	12 x 2½ x 1½	08 0511 55 00	4 007371 058216	

Das Set enthält: 1 Silikonbackmatte, 1 Deckel, 48 Papier-Stäbchen, Rezeptbuch

Popcake Stiele	Art.-Nr.	EAN	
48 Stück (Länge 10 cm)	08 0511 00 10	4 007371 059916	

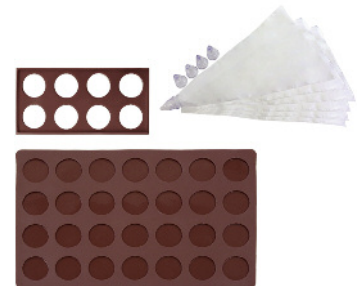





























Macaron-Set

macaron set
ensemble pour macarons
set per macarons
set para macarrón
macaron set

L/B/Ø cm	inch	Art.-Nr.	EAN	
36,5 x 23,5 x 4	14½ x 9 x 1½	08 0512 55 00	4 007371 058223	

Das Set enthält: 1 Silikonbackmatte, 1 Einfüllhilfe, Einweg-Spritzbeutel inklusive 5 Tüllen und Adapter für leichtes Wechseln der Tüllen, Rezeptbuch

Backen / Dekorieren

	<p>Ausstecher »Universal«, 4 Motive im Set</p> <p>cookie cutter emporte-pièce coppapasta molde para galleas uitsteekvormpjes</p>	<table border="1"> <thead> <tr> <th>Art.-Nr.</th> <th>EAN</th> <th>GP</th> </tr> </thead> <tbody> <tr> <td>08 1500 28 04</td> <td>4 007371 057080</td> <td></td> </tr> </tbody> </table> <p>Das Set enthält: 4 Ausstecher mit Auslöser, Motive: Herz, Bär, Erdbeere, Blatt</p>	Art.-Nr.	EAN	GP	08 1500 28 04	4 007371 057080							
Art.-Nr.	EAN	GP												
08 1500 28 04	4 007371 057080													
	<p>Ausstecher »X-MAS«, 4 Motive im Set</p> <p>cookie cutter emporte-pièce coppapasta molde para galleas uitsteekvormpjes</p>	<table border="1"> <thead> <tr> <th>Art.-Nr.</th> <th>EAN</th> <th>GP</th> </tr> </thead> <tbody> <tr> <td>08 1501 28 04</td> <td>4 007371 057097</td> <td></td> </tr> </tbody> </table> <p>Das Set enthält: 4 Ausstecher mit Auslöser, Motive: Weihnachtskugel, Lebkuchenmann, Schneemann, Weihnachtsbaum</p>	Art.-Nr.	EAN	GP	08 1501 28 04	4 007371 057097							
Art.-Nr.	EAN	GP												
08 1501 28 04	4 007371 057097													
	<p>Ausstecher »Ostern«, 4 Motive im Set</p> <p>cookie cutter emporte-pièce coppapasta molde para galleas uitsteekvormpjes</p>	<table border="1"> <thead> <tr> <th>Art.-Nr.</th> <th>EAN</th> <th>GP</th> </tr> </thead> <tbody> <tr> <td>08 1502 28 04</td> <td>4 007371 057103</td> <td></td> </tr> </tbody> </table> <p>Das Set enthält: 4 Ausstecher mit Auslöser, Motive: Küken, Schmetterling, Hase, Ei</p>	Art.-Nr.	EAN	GP	08 1502 28 04	4 007371 057103							
Art.-Nr.	EAN	GP												
08 1502 28 04	4 007371 057103													
	<p>Linzer Ausstecher-Set, 8 verschiedenen Formen inklusive Auswerfer</p> <p>linzer cookie cutter set emporte-pièce pour biscuits de Linz stampo per biscotti di Linz cortadores para galletas linzer vormpjes voor Linzer koekjes</p>	<table border="1"> <thead> <tr> <th>Art.-Nr.</th> <th>EAN</th> <th>GP</th> </tr> </thead> <tbody> <tr> <td>08 1509 28 04</td> <td>4 007371 058100</td> <td></td> </tr> </tbody> </table>	Art.-Nr.	EAN	GP	08 1509 28 04	4 007371 058100							
Art.-Nr.	EAN	GP												
08 1509 28 04	4 007371 058100													
	<p>Keks-Stempel »X-MAS«, 4-teilig</p> <p>cookie stamp timbre pour biscuits stampo per biscotti timbre para galletas koekstempel</p>	<table border="1"> <thead> <tr> <th>Ø cm</th> <th>Höhe cm</th> <th>Ø inch</th> <th>Art.-Nr.</th> <th>EAN</th> <th>GP</th> </tr> </thead> <tbody> <tr> <td>8,0</td> <td>10,0</td> <td>3</td> <td>08 1510 55 03</td> <td>4 007371 060547</td> <td></td> </tr> </tbody> </table> <p>Das Set enthält: 1 Stempel, 3 Motive: Schneeflocke, Weihnachtsbaum mit Schriftzug »Christmas«, Lebkuchenmann</p>	Ø cm	Höhe cm	Ø inch	Art.-Nr.	EAN	GP	8,0	10,0	3	08 1510 55 03	4 007371 060547	
Ø cm	Höhe cm	Ø inch	Art.-Nr.	EAN	GP									
8,0	10,0	3	08 1510 55 03	4 007371 060547										
	<p>Keks-Stempel »Universal«, 4-teilig</p> <p>cookie stamp timbre pour biscuits stampo per biscotti timbre para galletas koekstempel</p>	<table border="1"> <thead> <tr> <th>Ø cm</th> <th>Höhe cm</th> <th>Ø inch</th> <th>Art.-Nr.</th> <th>EAN</th> <th>GP</th> </tr> </thead> <tbody> <tr> <td>8,0</td> <td>10,0</td> <td>3</td> <td>08 1511 55 03</td> <td>4 007371 060554</td> <td></td> </tr> </tbody> </table> <p>Das Set enthält: 1 Stempel, 3 Motive: Schmetterling, Marienkäfer, Eule</p>	Ø cm	Höhe cm	Ø inch	Art.-Nr.	EAN	GP	8,0	10,0	3	08 1511 55 03	4 007371 060554	
Ø cm	Höhe cm	Ø inch	Art.-Nr.	EAN	GP									
8,0	10,0	3	08 1511 55 03	4 007371 060554										
	<p>Keks-Stempel »Ostern«, 4-teilig</p> <p>cookie stamp timbre pour biscuits stampo per biscotti timbre para galletas koekstempel</p>	<table border="1"> <thead> <tr> <th>Ø cm</th> <th>Höhe cm</th> <th>Ø inch</th> <th>Art.-Nr.</th> <th>EAN</th> <th>GP</th> </tr> </thead> <tbody> <tr> <td>8,0</td> <td>10,0</td> <td>3</td> <td>08 1512 55 03</td> <td>4 007371 060592</td> <td></td> </tr> </tbody> </table> <p>Das Set enthält: 1 Stempel, 3 Motive: Osterei, Osterhase, Blume mit Schriftzug »Happy Easter«</p>	Ø cm	Höhe cm	Ø inch	Art.-Nr.	EAN	GP	8,0	10,0	3	08 1512 55 03	4 007371 060592	
Ø cm	Höhe cm	Ø inch	Art.-Nr.	EAN	GP									
8,0	10,0	3	08 1512 55 03	4 007371 060592										

Backen / Dekorieren

Garnierspritze »Profi«



decorating and garnishing injection
seringue à décorer et garnir
siringa per decorare
jeringa para decorar
decoratie-en garneerspuit

Länge cm	inch	Art.-Nr.	EAN
24,0	9½	08 0560 28 00	4 007371 044387

aus Edelstahl rostfrei
inklusive 7 verschiedenen Tüllen

Dekorierflasche mit 2 Tüllen



decorating squeeze bottle
outeile à décorer
bottiglia per decorare
botella para decorar y racionar
dresseerfles

Ø cm	H cm	Inhalt	Ø inch	Art.-Nr.	EAN
5,5	13,0	100 ml	2	08 0569 00 00	4 007371 060493

20 Stück im attraktiven Verkaufs-Display,
farblich sortiert



Dekorier-/Garnierset



decorating set
ensemble à décorer et garnir
set per decorare
jeringa para decorar
decoratie- en garneerset

Art.-Nr.	EAN
08 0570 00 06	4 007371 055031

Set besteht aus:
3 Ziehharmonikaflaschen, 100 ml; 1 Zweikammernflasche, je 100 ml,
1 Dekorierflasche, 200 ml, 1 Spatel, 5 Edelstahl-Tüllen

Muffin-Form, »Herz«



cup cake mould
moule à muffin
forma per muffin
forma por muffin
muffinvorm

Ø cm	Höhe cm	Ø inch	Art.-Nr.	EAN
6,5	2,5	2½	08 0571 55 06	4 007371 055871

aus Silikon
6er-Set (grün, dunkelblau, hellblau, rot, orange, gelb)
geeignet für Spülmaschine, Backofen bis 260°C, Mikrowelle

Spritzbeutel-/Dekorierset



icing bag
poche à douille
tasca da pasticceria
manga pastelera
spuitzak

Länge cm	inch	Art.-Nr.	EAN
30,0	12	08 0580 00 00	4 007371 055901

Spritzbeutel aus Baumwolle, beschichtet/hochwertiger Kunststoff
inklusive 4 verschiedenen Tüllen



Backen / Dekorieren

Tortenring verstellbar, rund



cake ring
cercle à pâtisserie
anello per torta
aro de tarta
taartring

Ø cm	Höhe cm	Ø inch	Art.-Nr.	EAN
16,0	8,5	6½	08 0583 28 00	4 007371 05785 1

mit Griffen zum stufenlosen Einstellen von Ø 16 bis 30 cm

Tortenring verstellbar, mit Unterteiler, rechteckig



cake ring, rectangular
cadre à pâtisserie rectangulaire
anello per torta rettangolare
aro de tarta rectangular
taartring rechthoekig

L/B/H cm	inch	Art.-Nr.	EAN
18,5 x 27,5 x 5,0	7 x 11 x 2	08 0584 28 00	4 007371 05786 8

zum stufenlosen Einstellen von 18,5 x 27,5 bis 34,0 x 52,5 cm
mit Unterteiler für gleichzeitiges Backen
von 2 unterschiedlichen Kuchen

Konditormesser-Set, 3-teilig



icing spatula set
ensemble de couteaux de pâtissier
set di coltelli da pasticciere
set del cuchillos de pasteleros
paletmessen set

Art.-Nr.	EAN
08 0585 28 03	4 007371 05712 7

Das Set enthält: 1 Tortenmesser mit Wellenschliff und glatter Seite (39 cm), 1 Palette (29 cm), 1 Winkelpalette (25 cm)

Kuchengitter



cooling rack
volette à gateaux
raffreddatore rotondo
enfriador de tartas
tartenkoeler

Ø cm	Ø inch	Art.-Nr.	EAN
36,0	14	08 0587 28 36	4 007371 06068 4

Pudding-Form, 6er Set



pudding mould
moule à pudding
stampo per budino
moldes de flan y pudin
puddingvorm

Ø cm	Höhe cm	Ø inch	Art.-Nr.	EAN
7,5	6,0	3	08 0590 14 06	4 007371 05591 8

hochwertiger Kunststoff
Inhalt: 150 ml, temperaturbeständig bis: 90°C,
inklusive Belüftungsdeckel zum leichteren Stürzen des Puddings

Pudding-Form



pudding mould
moule à pudding
stampo per budino
moldes de flan y pudin
puddingvorm

Ø cm	Höhe cm	Ø inch	Art.-Nr.	EAN
15,0	11,0	6	08 0600 14 00	4 007371 05592 5

hochwertiger Kunststoff
Inhalt: 1 ltr., temperaturbeständig bis: 90°C,
inklusive Belüftungsdeckel zum leichteren Stürzen des Puddings

Backen / Dekorieren

Tarte- und Quicheform



quiche pan
moule à tarte
stampo torta
molde de tarta
taartvorm

Ø cm	Höhe cm	Ø inch	Art.-Nr.	EAN	
● 28,0	3,0	11	08 1000 10 28	4 007371 056823	
● 28,0	3,0	11	08 1000 14 28	4 007371 056830	

mit Hebeboden
antihafbeschichtet



Tarteletteform, 4 Stück im Set



round flan dish
moule à tartelette
stampo torta
molde de tarta
taartvorm

Ø cm	Höhe cm	Ø inch	Art.-Nr.	EAN	
● 11,5	3,0	4½	08 1001 10 04	4 007371 056847	
● 11,5	3,0	4½	08 1001 14 04	4 007371 056854	

mit Hebeboden
antihafbeschichtet



Springform »Herz«



springform pan
moule à charnières
teglia con fondo staccabile
molde de tarta
springvorm

L/B/H cm	inch	Art.-Nr.	EAN	
● 11,5 x 11,0 x 4,5	4½ x 4½ x 2	08 1002 10 12	4 007371 056861	
● 11,5 x 11,0 x 4,5	4½ x 4½ x 2	08 1002 14 12	4 007371 056878	

mit Hebeboden
antihafbeschichtet



Backen / Dekorieren

Blindbackkugeln



baking beans
billes de cuisson
sfere per cottura
judias para tartas
blindbakbonen

Art.-Nr. EAN

08 1010 83 00



Keramik,
Inhalt: 850g
zum Blindbacken von Pies, Tartes und Quiches,
ausreichend für Backformen bis 30 cm

Fleischwolf mit Spritzgebäckvorsatz



meat grinder
hachoir à viande
tritacarne
tritador de carne
gehaktmolen

Ø cm Ø inch Art.-Nr. EAN



Größe 5

5,0

2

08 0255 30 05



Größe 8

8,0

3

08 0255 30 08



Messbecher, mit Griff



measuring cup
gobelet mesureur
misurino cucina
jarra medidora
maatbeker

Ø cm Höhe cm Inhalt ltr. Ø inch Art.-Nr. EAN

10,5

14,5

1,0

2 1/2

09 1180 28 10



Marmor-Teigrolle mit Holzgriffen



rolling pin
rouleau pâtisserie marbre
mattarello marmo
rodillo pasta
deegrol marmer

Ø cm Länge cm inch Art.-Nr. EAN

6,0

47,0

1 1/2

10 0248 10 47



Marmor und Holz, inklusive Ablage

Einhand-Mehlsieb



flour sieve
saupoudreur tamis farine
passafarina
jarra tamiz
schudzeef

Ø cm Höhe cm Ø inch Art.-Nr. EAN

9,5

9,0

3 1/2

10 0700 28 00



Silikon-Teigschaber/ Eierwender



pastry scraper
râcloir à pâte
lecca piatti
espátula masa
deegschrapper

Design: Ralph Krämer

Länge cm inch Art.-Nr. EAN

blau

29,5

11 1/2

10 0805 12 00



weiß

29,5

11 1/2

10 0805 22 00



blau

25,5

10

10 0807 12 00



weiß

25,5

10

10 0807 22 00



Backen / Dekorieren

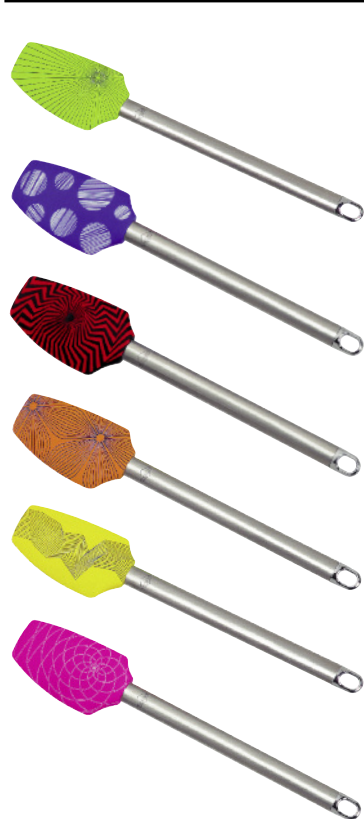

Teigschaber »Fancy«

pastry scraper
râcloir à pâte
lecca piatti
espátula masa
deegschrapper

	Länge cm	inch	Art.-Nr.	EAN
grün	30,5	12	10 0816 11 00	4 007371 058919
blau	30,5	12	10 0816 12 00	4 007371 058926
rot	30,5	12	10 0816 14 00	4 007371 058933
orange	30,5	12	10 0816 15 00	4 007371 058940
gelb	30,5	12	10 0816 16 00	4 007371 058957
pink	30,5	12	10 0816 21 00	4 007371 058964

Temperaturbeständige Silikon-Laffe: -60°C bis +300°C



Kinderschürze, mit 2 Handschuhen

children´s apron with 2 gloves
ensemble de tablier 2 et gants
set con parannanza e 2 guanti
juego de mandil 2 y guantes
set met schort en 2 keukenhandschoenen

L/B cm	inch	Art.-Nr.	EAN
60,0 x 46,0 cm	23½ x 18	10 6020 12 00	4 007371 058087

100% Baumwolle



Kuchenthermometer

cake thermometer
thermomètre a gâteau
termometro per torta
termómetro para torta
koekthermomete

Länge cm	Ø	inch	Art.-Nr.	EAN
11,5	4,5	4½	10 6509 28 00	4 007371 058117



Kuchenretter/Pizzaheber

cake lifter / pizza server
pelle à pizza/tarte
pala pizza/tarta
paleta para pizza y pasteles
taart-/pizzaschep

L/B cm	inch	Art.-Nr.	EAN
36,0 x 25,0 cm	14 x 10	10 8900 28 00	4 007371 050463

Praktische Küchenhelfer

Brotkästen, Küchenwaagen im Nostalgie-Look sowie unersetzliche Helfer für den täglichen Einsatz in der Küche prägen das gesamte KÜCHENPROFI Sortiment und erleichtern die Arbeit in der Küche.



Brotkästen

rostfrei/pulverbeschichtet / stainless/powder-coated

Praktische Küchenhelfer

Brotkasten »Corona«

bread box
boîte a pain
porta pane
centro pan
broodtrommel

L/B/H cm	inch	Art.-Nr.	EAN	GP
42,5 x 22,5 x 17	16 7/8 x 9 x 6 7/8	09 0316 10 00	4 007371 059176	

Belüftungslöcher auf der Rückseite sorgen für ein optimales Klima, rutschfeste Füßchen



Kurz Kurz Design

Brotkasten »Corona«

bread box
boîte a pain
porta pane
centro pan
broodtrommel

L/B/H cm	inch	Art.-Nr.	EAN	GP
42,5 x 22,5 x 17	16 7/8 x 9 x 6 7/8	09 0316 11 00	4 007371 059183	

Belüftungslöcher auf der Rückseite sorgen für ein optimales Klima, rutschfeste Füßchen



Kurz Kurz Design

Brotkasten »Corona«

bread box
boîte a pain
porta pane
centro pan
broodtrommel

L/B/H cm	inch	Art.-Nr.	EAN	GP
42,5 x 22,5 x 17	16 7/8 x 9 x 6 7/8	09 0316 14 00	4 007371 059190	

Belüftungslöcher auf der Rückseite sorgen für ein optimales Klima, rutschfeste Füßchen



Kurz Kurz Design

Brotkasten »Corona«

bread box
boîte a pain
porta pane
centro pan
broodtrommel

L/B/H cm	inch	Art.-Nr.	EAN	GP
42,5 x 22,5 x 17	16 7/8 x 9 x 6 7/8	09 0316 22 00	4 007371 059206	

Belüftungslöcher auf der Rückseite sorgen für ein optimales Klima, rutschfeste Füßchen



Kurz Kurz Design

GP = Produkt in farbigem Geschenkkarton

KE = auf Karte mit Euroloch

Küchenwaagen

Edelstahl rostfrei / stainless steel



Küchenwaage »Nostalgie«

kitchen scales
balance de cuisine
bilancia per la cucina
balanza cocina
keuken-weegschaal

L/B/H cm	inch	Art.-Nr.	EAN
21,0 x 20,0 x 25,0	8¼ x 7¾ x 9¾	09 0330 28 00	4 007371 033824

Wiegebereich: bis 2 kg in 10g-Schritten
Fassungsvermögen der abnehmbaren Schale: 1 ltr.



Küchenwaage »Nostalgie«

kitchen scales
balance de cuisine
bilancia per la cucina
balanza cocina
keuken-weegschaal

L/B/H cm	inch	Art.-Nr.	EAN
21,0 x 20,0 x 25,0	8¼ x 7¾ x 9¾	09 0330 10 00	4 007371 060011

Wiegebereich: bis 2 kg in 10g-Schritten
Fassungsvermögen der abnehmbaren Schale: 1 ltr.



Küchenwaage »Nostalgie«

kitchen scales
balance de cuisine
bilancia per la cucina
balanza cocina
keuken-weegschaal

L/B/H cm	inch	Art.-Nr.	EAN
21,0 x 20,0 x 25,0	8¼ x 7¾ x 9¾	09 0330 14 00	4 007371 060028

Wiegebereich: bis 2 kg in 10g-Schritten
Fassungsvermögen der abnehmbaren Schale: 1 ltr.



Küchenwaage »Nostalgie«

kitchen scales
balance de cuisine
bilancia per la cucina
balanza cocina
keuken-weegschaal

L/B/H cm	inch	Art.-Nr.	EAN
21,0 x 20,0 x 25,0	8¼ x 7¾ x 9¾	09 0330 22 00	4 007371 060035

Wiegebereich: bis 2 kg in 10g-Schritten
Fassungsvermögen der abnehmbaren Schale: 1 ltr.

Praktische Küchenhelfer

Edelstahl rostfrei / stainless steel

Praktische Küchenhelfer



Fleischklopper »Classic«

meat pounder
marteau à viande
batticarne
mazo de cocina
vleesklopper

Ø cm	Höhe cm	Ø inch	Art.-Nr.	EAN	
8,0	12,0	3	08 0101 28 08	4 007371 008563	

Gewicht: ca. 800 g

Fleischklopper/ Küchenbeil

meat pounder / cleaver
marteau à viande / hachette
batticarne / accetta per carne
mazo de cocina / hachuela
vleesklopper



Länge cm	inch	Art.-Nr.	EAN	
27,5	11	08 0103 28 00	4 007371 039789	

Gewicht: ca. 330 g

Fleischklopper

meat pounder
marteau à viande
batticarne
mazo de cocina
vleesklopper



Ø cm	Länge cm	Ø inch	Art.-Nr.	EAN	
10,0	25,5	4	08 0104 28 00	4 007371 040204	

Gewicht: ca. 860 g

Fleischklopper »Chef«

meat pounder
marteau à viande
batticarne
mazo de cocina
vleesklopper



Länge cm	inch	Art.-Nr.	EAN	
25,0	10	08 0105 28 00	4 007371 047876	

Gewicht: ca. 400 g

Panier-Set, 3-teilig

breeding set, 3 pcs.
ensemble pour paner, 3 pcs.
set per impanare, 3 pz.
set para empanar, 3 pzs.
paneer-set, 3-dlg.



L/B/H cm	inch	Art.-Nr.	EAN	
22,0 x 15,0 x 3,0	8½ x 6 x 1	08 0110 28 03	4 007371 038690	

zum Panieren, Marinieren, Portionieren

Praktische Küchenhelfer

Edelstahl rostfrei / stainless steel

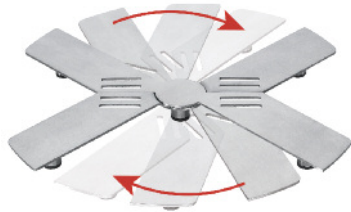

Untersetzer, verstellbar

adjustable trivet
dessous de plat ajustable
sottopentola orientabile
salvamanteles ajustable
onderzetter verstelbaar

L/B/H cm	inch	Art.-Nr.	EAN
26,0 x 17,5	10 x 3	08 0126 28 00	4 007371 057844

Verstellbar von 26 cm x 8 cm bis 22 cm x 17,6 cm



Trüffelhobel

truffle plane
râpe à truffe
tagliatartufi
cortadora de trufa
truffelrasp

L/B cm	inch	Art.-Nr.	EAN
17,5 x 8,5	7 x 3½	08 0406 28 00	4 007371 010580

auch für Parmesan u. a.
Schnittstärke bis 3 mm



Spritzschutzsieb »Deluxe«

anti splash sieve
tamis anti-éclaboussure
paraspruzzi
pasador anti saipicados
spatzeef

Ø cm	Ø inch	Art.-Nr.	EAN
29,0	11½	08 0805 28 29	4 007371 043618

passend bis Ø 28 cm

33,0	13	08 0810 28 33	4 007371 043625
------	----	---------------	-----------------

passend bis Ø 32 cm



Spritzschutzsieb

anti splash sieve
tamis anti-éclaboussure
paraspruzzi
pasador anti saipicados
spatzeef

Ø cm	Ø inch	Art.-Nr.	EAN
29,0	11½	08 0810 28 29	4 007371 035712

passend bis Ø 28 cm

33,0	13	08 0810 28 33	4 007371 041041
------	----	---------------	-----------------

passend bis Ø 32 cm



Abgieß-Sieb

pour off sieve
tamis égouttoir
colino
pasador vertidora
afgietzeef

Breite cm	inch	Art.-Nr.	EAN
33,5	13	08 0821 28 00	4 007371 034364

passend bis Ø 24 cm

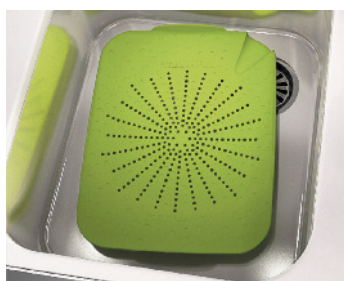

Siebeinsatz »sinkstation™«, für die Spüle; Kunststoff

flat colander
égouttoir plat
colapasta
escurreverduras
plat vergiet

L/B cm	inch	Art.-Nr.	EAN
34,0 x 27,0	13½ x 11	08 0835 11 00	4 007371 056649

mit praktischen Füßen und seitlichem Ablauf,
ideal beim Putzen von Gemüse, Waschen von Salat oder Beeren oder
Abgießen von Resten
nicht geeignet für runde Spülbecken



Dessert- und Vorspeisenringe

Edelstahl rostfrei / stainless steel

Dessert- und Vorspeisenringe, 6-teilig

decorating and dessert rings
emporte-pièce
aro decorador
formina anello
kook- en dessertring



Art.-Nr.	EAN	
09 0498 28 06	4 007371 054782	

Set besteht aus:

2 Dessert- und Vorspeisenringen Ø 7,5 cm,
2 Dessert- und Vorspeisenringen Ø 5 cm,
1 Auslöser Ø 7,25 cm, 1 Auslöser Ø 4,85 cm

Dessert- und Vorspeisenringe »Mixed«

decorating and dessert rings
emporte-pièce
aro decorador
formina anello
kook- en dessertring



Höhe cm	inch	Art.-Nr.	EAN	
5,0	2	09 0500 28 04	4 007371 043885	

4 Stück im Set:

2 Stück mit Ø 8 cm und 2 Stück mit Ø 6 cm

Dessert- und Vorspeisenringe

decorating and dessert rings
emporte-pièce
aro decorador
formina anello
kook- en dessertring



Höhe cm	Ø	inch	Art.-Nr.	EAN
5,0	8 cm	2	09 0505 28 00	4 007371 051873

18 Stück im attraktiven Verkaufs-Display

Dessert- und Vorspeisenringe »Grande«

decorating and dessert rings
emporte-pièce
aro decorador
formina anello
kook- en dessertring



Höhe cm	Ø	inch	Art.-Nr.	EAN	
5,0	8 cm	2	09 0505 28 04	4 007371 045445	

4 Stück im Set

Dessert- und Vorspeisenring, verstellbar

decorating and dessert rings
emporte-pièce
aro decorador
formina anello
kook- en dessertring



Höhe cm	inch	Art.-Nr.	EAN	
5,5	2	09 0509 28 00	4 007371 052672	

Ø 7,0 - 9,0

18 Stück im attraktiven Verkaufs-Display

Terrinen

Edelstahl rostfrei / stainless steel



Terrinenform mit Deckel, rund

tureen mould
terrine
terrina
terrina
patévorm

L/B/H cm	Inhalt ltr.	inch	Art.-Nr.	EAN
30,5 x 6,0 x 6,0	0,7	12 x 2½ x 2½	09 2101 28 00	4 007371 033497

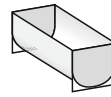

Terrinenform mit Deckel, rund

tureen mould
terrine
terrina
terrina
patévorm

L/B/H cm	Inhalt ltr.	inch	Art.-Nr.	EAN
23,5 x 8,0 x 7,5	0,9	9 x 3 x 3	09 2106 28 00	4 007371 045858

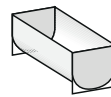

Terrinenform mit Deckel, Dreieck

tureen mould
terrine
terrina
terrina
patévorm

L/B/H cm	Inhalt ltr.	inch	Art.-Nr.	EAN
30,0 x 5,5 x 5,5	0,45	12 x 2 x 2	09 2107 28 00	4 007371 045865

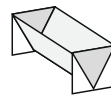

Terrinenform mit Füllungseinsatz

tureen mould
terrine
terrina
terrina
patévorm

Ø cm	Höhe cm	Inhalt ltr.	Ø inch	Art.-Nr.	EAN
7,5	12,0	0,5	3	09 2120 28 00	4 007371 057592



difo
Design International



Dekorierschneider, 4-teilig

decoration cutter
evideur pour decorer
taglia per decorare
cortador para decorar
decoratie snijder

Länge cm	inch	Art.-Nr.	EAN
11,0	4½	09 2130 28 04	4 007371 057677

Ergänzung zur Terrinenform mit Füllungseinsatz
Das Set enthält: 1 Griff, 4 Dekorierschneider - Motive: Stern, Kreuz, Blume, Herz, 1 Bedienungsanleitung



GP = Produkt in farbigem Geschenkkarton

KE = auf Karte mit Euroloch

Praktische Küchenhelfer

Edelstahl rostfrei / stainless steel



Kühlschrank-Butterdose

butter dish
beurrier
porta burro
mantequera
botervloot

L/B/H cm	inch	Art.-Nr.	EAN	
16,0 x 10,0 x 5,0	6 1/4 x 4 x 2	09 1202 28 00	4 007371 035040	

für 1/2 Pfund Butter (250g)



Kühlschrank-Butterdose

butter dish
beurrier
porta burro
mantequera
botervloot

L/B/H cm	inch	Art.-Nr.	EAN	
10,0 x 13,0 x 4,0	4 x 5 x 1 1/2	09 1203 28 00	4 007371 035798	

für 1/4 Pfund Butter (125g)



Pellkartoffel-Set

jacket potato fork
and knife set
set fourchette et couteau
à pomme de terre
set coltello e forchetta per patate
tenedor y cuchillo set
para patatas cocidas
aardappel pel-set

Länge cm	inch	Art.-Nr.	EAN	
15,0	6	09 1350 28 00	4 007371 042772	

4 Stück im Set: 2 x Gabel und 2 x Messer



Tomatenstrunkentferner

tomato corer
évideur à tomate
attrezzo togliorsolo pomodoro
vaciador del corazón del tomate
tomaatkroon-verwijderaar

Länge cm	inch	Art.-Nr.	EAN	
13,0	5	09 1400 28 00	4 007371 046121	

24 Stück im attraktiven Verkaufs-Display



Geflügelschere

poultry scissors
cisailles à volaille
trinciapolli
tijeras aves
gevogelte-schaar

Länge cm	inch	Art.-Nr.	EAN	
25,0	10	09 2300 28 00	4 007371 034906	

mit Sicherheitsverschluss



Geflügelschere »Profi«

poultry scissors
cisailles à volaille
trinciapolli
tijeras aves
gevogelte-schaar

Länge cm	inch	Art.-Nr.	EAN	
24,0	9 1/2	09 2350 28 00	4 007371 047685	

mit Sicherheitsverschluss

Praktische Küchenhelfer

Edelstahl rostfrei / stainless steel

Designed and produced
by **triangle****Endlos-Spiralschneider**

endless spiral cutter
coupe-légumes spirale
taglia a spirale
cortador en espiral
oneindige spiraal snijder

L/B cm	inch	Art.-Nr.	EAN	GP
11,0 x 7,5	4½ x 3	09 3500 15 00	4 007371 060318	

**Endlos-Julieneschneider**

endless julienne cutter
coupe-légumes juliennes
taglia julienne a spirale
cortador en juliana
oneindige julienne snijder

L/B cm	inch	Art.-Nr.	EAN	GP
11,0 x 7,5	4½ x 3	09 3501 14 00	4 007371 060325	

**Aromareibe**

flavour grater
rape à saveur
grattugia zenzero/limone
rallador para especias
aroma rasp

L/B cm	inch	Art.-Nr.	EAN	GP
19,0 x 4,5	7½ x 1½	09 3502 10 00	4 007371 060332	

**Rettichschneider**

spiral cutter
trancheur à radis blanc
tagliarapanelli
decorador en guirnalda
rettich snijder

L/B cm	inch	Art.-Nr.	EAN	GP
11,5 x 0,4	4½ x ¼	09 3503 14 00	4 007371 060349	

mit Führungsstab

**Apfelteiler,
inklusive Unterschale**

apple divider and corer for 16 slices
trancheur à pomme 16 quartiers
tagliamele per 16 spicchi
cortador para manzanas 16 porciones
appelsnijder voor 16 partjes

L/B cm	inch	Art.-Nr.	EAN	GP
17,5 x 5,5	7 x 2	09 3504 11 00	4 007371 060356	

für 16 Spalten, schneidet den Apfel restlos durch

**Wellenschneider**

crinkle cutter
coupe légume ondulé
coltello ondulato
cortador ondulado
ribbelsnijder

L/B cm	inch	Art.-Nr.	EAN	GP
9,0 x 9,0	3½ x 3½	09 3505 10 00	4 007371 060363	

für alle festen Gemüsesorten und auch Butter

Design: Ralph Krämer

**Julienne-Set, 3-teilig**

julienne cutter set
set à julienne
taglia a julienne
set de cortadores en juliana
julienne set

L/B cm	inch	Art.-Nr.	EAN	GP
19,5 x 7,5	7½ x 3	09 3506 10 00	4 007371 060370	

mit 3 auswechselbaren Klingen:
dünne Julienne, breite Julienne, Scheiben

GP = Produkt in farbigem Geschenkkarton

KE = auf Karte mit Euroloch

Praktische Küchenhelfer

Edelstahl rostfrei / stainless steel

Praktische Küchenhelfer

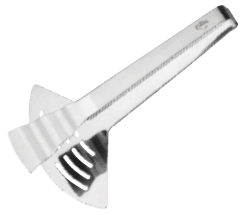

Fisch-/Spargelzange

fish/asparagus tongs
pince à poisson
pinza pesce
pinzas pescado
vis-/aspergetang

Länge cm	inch	Art.-Nr.	EAN	
24,0	9½	09 4001 28 00	4 007371 023535	

Design: Ralph Krämer



Fischgräten-Pinzette

fishbone tweezers
pincette à arêtes
pinze per spine di pesce
pinzas por espina
gratenpincet

Länge cm	inch	Art.-Nr.	EAN	
12,0	5	09 4007 28 00	4 007371 041140	



Fischgräten-Pinzette »Deluxe«

fishbone tweezers
pincette à arêtes
pinze per spine di pesce
pinzas por espina
gratenpincet

Länge cm	inch	Art.-Nr.	EAN	
13,0	5	09 4009 28 00	4 007371 045513	

made in Solingen – Germany



Fischentschupper

fish scaler
écailleur
squamapesce
descamador para pescado
visontshubber

Länge cm	inch	Art.-Nr.	EAN	
19,0	7½	09 4010 28 00	4 007371 045704	



Servierzange

serving tongs
pince à servir
pinza per servire
pinza para frituras
baktang

Länge cm	inch	Art.-Nr.	EAN	
27,5	11	09 4300 28 00	4 007371 049474	



Pfannen-/Wendegabel »Deluxe«

turning fork
fourchette à tourner
forchetta per rivoltare
tenedor para remover
bakfork

Länge cm	inch	Art.-Nr.	EAN	
30,0	12	09 7500 10 00	4 007371 045216	

Funktionsteil aus temperaturbeständigem Nylon (bis 220°C)
ideal für beschichtete Pfannen

Passieren, Einkochen und andere Helfer

Regionale und saisonale Produkte stehen wir volles Aroma – leider nur für eine begrenzte Zeit. Zum Verlängern der Genusszeit stehen Ihnen mit den KÜCHENPROFI-Accessoires zum Einkochen die idealen Begleiter zur Seite.



Passieren und Einmachen

Edelstahl rostfrei / stainless steel



Marmeladen-/Einfülltrichter, 2-teilig

jam funnel
entonnoir à confiture
imbuto per marmellata
embudo para mermelada
jamtrecther

L/B cm	inch	Art.-Nr.	EAN
16,5 x 10,5	6½ x 4	09 2009 28 14	4 007371 054959

mit abnehmbarem Reduziertrichter
passend für Behälter mit einem
Öffnungsdurchmesser von 1,5 cm bis 5,5 cm



Marmeladentrichter mit Siebeinsatz

funnel with filter
entonnoir avec filtre
imbuto con filtro
embudo con filtro
trechter met filter

Ø cm	Höhe cm	Ø inch	Art.-Nr.	EAN
13,0	9,0	5	09 2015 28 00	4 007371 038591



Trichter

funnel
entonnoir
imbuto
embudo
trechter

Ø cm	Ø inch	Art.-Nr.	EAN
10,0	4	09 2017 28 10	4 007371 014014



Marmeladentrichter

jam funnel
entonnoir à confiture
imbuto per marmellata
embudo para mermelada
jamtrecther

Ø cm	Ø inch	Art.-Nr.	EAN
14,0	5½	09 2018 28 00	4 007371 015059



Zuckerthermometer

candy thermometer
thermomètre à confiture
termometro per zucchero
termómetro para azúcar
suikerthermometer

Länge cm	inch	Art.-Nr.	EAN
30,0	12	10 6570 28 00	4 007371 048392

Temperaturbereich 40°C – 200°C / 100°F – 400°F

Passieren und Einmachen

Edelstahl rostfrei / stainless steel



Passiergerät, klein

vegetable sieve / food mill
passoire
passa verdura
pasapurés
passeermolen

Ø cm	Ø inch	Art.-Nr.	EAN
14,0	5½	09 6560 28 14	4 007371 036917

mit fester Scheibe



Passiergerät »Profi«

vegetable sieve / food mill
passoire
passa verdura
pasapurés
passeermolen

Ø cm	Ø inch	Art.-Nr.	EAN
20,0	8	09 6600 28 20	4 007371 036665

mit 4 Scheiben



Passierscheibe: 1,3mm

Reibscheibe: 2,5mm

Passierscheibe: 3mm

Passierscheibe: 5mm

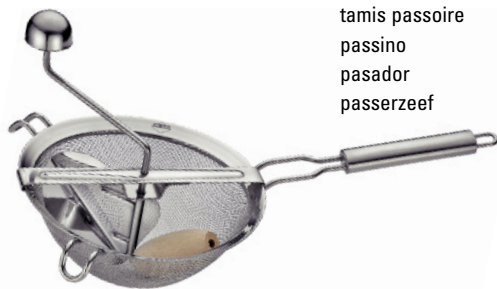

Passiersieb

sieve strainer
tamis passoire
passino
pasador
passerzeef

Ø cm	Ø inch	Art.-Nr.	EAN
20,0	8	09 6601 28 20	4 007371 058094



Gemüsebürste

vegetable brush
brosse à légumes
spazzolino per verdura
cepillo para verdura
groente-borstel

L/B/H cm	inch	Art.-Nr.	EAN
13,5 x 5,5 x 3,5	5½ x 2 x 1½	09 7350 10 00	4 007371 055734

Griff aus Buchenholz



Champignonbürste

mushroom brush
brosse à champignon
spazzolino per funghi
cepillo seta
paddestoel-borstel

Ø cm	Ø inch	Art.-Nr.	EAN
4,5	2	09 7400 28 00	4 007371 042505

Schönes und Nützliches

Die nützlichen Accessoires sind sowohl bei ambitionierten Hobbyköchen als auch beim Profi gleichermaßen gern gesehen. Attraktive Lunchboxen, praktische Löffelablagen und Papierrollenhalter für sauberes Arbeiten in der Küche.



Praktische Küchenhelfer



Lunchbox, anthrazit

lunchbox
lunch box
lunch box
fiambrella
lunch box

L/B/H cm	inch	Art.-Nr.	EAN
18,0 x 12,0 x 5,0	7x4½x2	10 0146 13 18	4 007371 057332
23,0 x 15,0 x 7,0	9x6x3	10 0147 13 23	4 007371 057356

Aluminium, mit Trennsteg
Deckel mit Silikondichtung

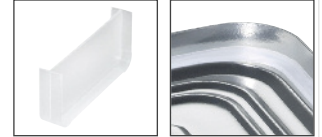

Lunchbox, rot

lunchbox
lunch box
lunch box
fiambrella
lunch box

L/B/H cm	inch	Art.-Nr.	EAN
18,0 x 12,0 x 5,0	7x4½x2	10 0146 14 18	4 007371 056090
23,0 x 15,0 x 7,0	9x6x3	10 0147 14 23	4 007371 056113

Aluminium, mit Trennsteg
Deckel mit Silikondichtung

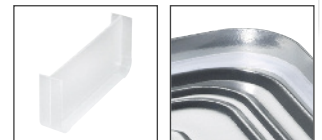

Lunchbox, silber

lunchbox
lunch box
lunch box
fiambrella
lunch box

L/B/H cm	inch	Art.-Nr.	EAN
18,0 x 12,0 x 5,0	7x4½x2	10 0146 24 18	4 007371 056083
23,0 x 15,0 x 7,0	9x6x3	10 0147 24 23	4 007371 056106

Aluminium, mit Trennsteg
Deckel mit Silikondichtung

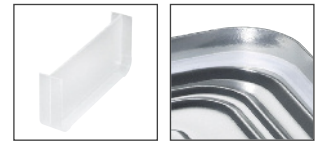

Profi-Löffelablage

professional spoon rest
porte cuillère profi
portacucchiaio profi
reposa cuchara profi
profi lepel afdruijbordje

L/B/H cm	inch	Art.-Nr.	EAN
26,5 x 11,0 x 3,0	10½ x 4½ x 1	10 0222 28 00	4 007371 043106



Kochlöffelständer

cooking spoon holder
support de cuillère à pot
appoggia mestolo
reposa utensilios
kooklepelboy

Ø cm	Höhe cm	Ø inch	Art.-Nr.	EAN
11,0	16,0	4½	10 0232 28 00	4 007371 033770

inklusive Porzellan-Schälchen und Holzlöffel



Löffelablage

spoon rest
porte cuillère
portacucchiaio
reposa cuchara
lepel afdruijbordje

L/B/H cm	inch	Art.-Nr.	EAN
25,5 x 8,5 x 2,0	10 x 3 x 1	10 0234 28 00	4 007371 037235

Praktische Küchenhelfer

Schönes und Nützlich



Papierrollenhalter »Deluxe« mit Stopper

paper towel holder
support papier de cuisine
portarotoli tavolo
soporte papel cocina
keukenrolhouder

Ø cm	Höhe cm	Ø inch	Art.-Nr.	EAN
13,0	35,5	5	10 0236 28 00	4 007371 035736



Papierrollenhalter mit Fixierfeder

paper towel holder
support papier de cuisine
portarotoli tavolo
soporte papel cocina
keukenrolhouder

Ø cm	Höhe cm	Ø inch	Art.-Nr.	EAN
17,0	32,5	6½	10 0239 28 00	4 007371 038522



Papierrollenhalter »Style«

paper towel holder
support papier de cuisine
portarotoli tavolo
soporte papel cocina
keukenrolhouder

Ø cm	Höhe cm	Ø inch	Art.-Nr.	EAN
15,5	33,0	6	10 0241 28 00	4 007371 060646

VLBER
DESIGN

Papierrollenhalter

paper towel holder
support papier de cuisine
portarotoli tavolo
soporte papel cocina
keukenrolhouder

	Ø cm	Höhe cm	Ø inch	Art.-Nr.	EAN	GP
●	15,5	30,0	6	10 0750 10 00	4 007371 057738	
●	15,5	30,0	6	10 0750 11 00	4 007371 057745	
●	15,5	30,0	6	10 0750 14 00	4 007371 057752	
●	15,5	30,0	6	10 0750 22 00	4 007371 061124	



GP = Produkt in farbigem Geschenkkarton

KE = auf Karte mit Euroloch

Würze und Co.

Frische Kräuter und Gewürze sind unerlässliche Zutaten, um Ihren Speisen eine besondere Note zu verleihen. Damit das Aroma voll zur Geltung kommt und den Geschmack der Gerichte unterstreicht finden Sie im KÜCHENPROFI- Sortiment passende Accessoires wie Mörser oder Wiegemesser.

Im KÜCHENPROFI Sortiment finden Sie hierfür die passenden Mörser aus Porzellan oder hochwertigem Marmor.

Mit den Essig-Sprühern und Öl-Spendern lassen sich Ihre Speisen wohldosiert verfeinern, besonders empfehlenswert für das ernährungsbewusste Kochvergnügen.



Würze und Co.

Edelstahl rostfrei / stainless steel

Würze und Co.

Gewürzgläser im Set



herb canister, 2 pcs.
boîte à épices, 2 pcs
barattolo per spezie, 2 pz.
tarro especies, 2 pzs.
kruidendoos, 2 stuks

Ø cm	Höhe cm	Inhalt ltr.	inch	Art.-Nr.	EAN	GP
5,5	10,0	2 x 0,125	2	10 0130 28 02	4 007371 044417	

Edelstahldeckel mit Silikonring

Muskatmühle »New Orleans«



nutmeg mill
moulin à muscade
grattugia noce moscata
molinillo nuez moscada
nootmuskaatmolen

Ø cm	Höhe cm	Ø inch	Art.-Nr.	EAN	GP
10,0	10,5	4	10 0215 38 00	4 007371 051422	

Acryl / Chrom
Mühle wird ohne Muskatnüsse geliefert

Muskatmühle »Miami«



nutmeg mill
moulin à muscade
grattugia noce moscata
molinillo nuez moscada
nootmuskaatmolen

Ø cm	Höhe cm	Ø inch	Art.-Nr.	EAN	GP
5,0	21,0	2	10 0216 10 00	4 007371 058018	

Kunststoff / Edelstahl
Mühle wird ohne Muskatnüsse geliefert

Muskatmühle »Deluxe«



nutmeg mill
moulin à muscade
grattugia noce moscata
molinillo nuez moscada
nootmuskaatmolen

Ø cm	Höhe cm	Ø inch	Art.-Nr.	EAN	GP
8,5	9,0	3½	10 0220 66 00	4 007371 026802	

Acryl / Chrom
Mühle wird ohne Muskatnüsse geliefert

Muskatreibe »Classic«



nutmeg grater
râpe à muscade
grattugia noce moscata
rallador nuez moscada
nootmuskaatrasp

Länge cm	inch	Art.-Nr.	EAN	GP
15,0	6	10 0230 28 00	4 007371 027984	

Tisch-Feinstreuer, mit Aromaschutzhaube



fine dredger
saupoudreur à filet
spargitutto fino
esparcidor fino
fijne strooier

Ø cm	Höhe cm	Inhalt ltr.	inch	Art.-Nr.	EAN	GP
6,0	8,0	0,2	3	10 0307 28 00	4 007371 026451	

Tisch-Grobstreuer, mit Aromaschutzhaube



coarse dredger
saupoudreur à gros
spargitutto grosso
esparcidor grueso
grove strooier

Ø cm	Höhe cm	Inhalt ltr.	inch	Art.-Nr.	EAN	GP
6,0	8,0	0,2	3	10 0308 28 00	4 007371 026468	

Tisch-Netzstreuer, mit Aromaschutzhaube



net dredger
saupoudreur à filet
spargitutto a rete
esparcidor de red
cacaostrooier

Ø cm	Höhe cm	Inhalt ltr.	inch	Art.-Nr.	EAN	GP
6,0	8,0	0,2	3	10 0309 28 00	4 007371 026475	

Mörser-Kollektion

Marmor / Porzellan



Mörser Marmor

mortar marble
mortier marbre
mortaio marmo
mortero
vijzel marmer

Ø cm	Höhe cm	Ø inch	Art.-Nr.	EAN	GP
9,5	4,5	3½	10 0243 08 08	4 007371 018937	
11,0	7,0	4½	10 0243 08 11	4 007371 018944	



Mörser Marmor, schwarz

mortar marble
mortier marbre
mortaio marmo
mortero
vijzel marmer

Ø cm	Höhe cm	Ø inch	Art.-Nr.	EAN	GP
11,0	7,0	4½	10 0243 10 11	4 007371 039765	



Mörser Marmor mit Fuß

mortar marble
mortier marbre
mortaio marmo
mortero
vijzel marmer

Ø cm	Höhe cm	Ø inch	Art.-Nr.	EAN	GP
12,0	11,5	4¾	10 0250 08 12	4 007371 033695	



Mörser Marmor »Trento«

mortar marble
mortier marbre
mortaio marmo
mortero
vijzel marmer

Ø cm	Höhe cm	Ø inch	Art.-Nr.	EAN	GP
14,5	7,5	5¾	10 0253 08 15	4 007371 056892	



Mörser Porzellan

porcelain mortar
mortier en porcelaine
mortaio porcellana
mortero porcelana
vijzel porselein

Ø cm	Höhe cm	Ø inch	Art.-Nr.	EAN	GP
7,0	4,0	3	10 0673 82 07	4 007371 048828	
9,0	5,0	3½	10 0673 82 09	4 007371 020619	
12,0	6,5	4¾	10 0673 82 12	4 007371 020626	
14,0	8,0	5¾	10 0673 82 14	4 007371 048835	
16,0	9,0	6¾	10 0673 82 16	4 007371 057684	



Würze und Co.

Edelstahl rostfrei / stainless steel

Würze und Co.



Essig-Sprüher & Öl-Spender »Tavola« im Set, matt

vinegar sprayer & oil dispenser
vaporisateur de vinaigre &
distributeur d'huile
vaporizzatore aceto & porzionatore olio
vaporizador vinagre & porcinador aceite
azijn-verstuiver & oliepom

Ø cm	Höhe cm	Inhalt ltr.	inch	Art.-Nr.	EAN	GP
3,8	19,0	0,11	1½	10 0506 28 11	4 007371 044479	



Olivenölsprüher »Mephisto«, matt

olive oil sprayer
vaporisateur d'huile d'olive
vaporizzatore olio de oliva
vaporizador aceite de oliva
olijfolie-verstuiver

Ø cm	Höhe cm	Inhalt ltr.	inch	Art.-Nr.	EAN	GP
5,0	19,0	0,2	2	10 0507 28 00	4 007371 038492	

mit Pumpmechanismus



Essig-Sprüher & Öl-Spender »Trattoria«, matt

vinegar sprayer & oil dispenser
vaporisateur de vinaigre &
distributeur d'huile
vaporizzatore aceto & porzionatore olio
vaporizador vinagre & porcinador aceite
azijn-verstuiver & oliepom

Ø cm	H cm	Inhalt ltr.	inch	Art.-Nr.	EAN	GP
Essig:						
5,0	19,0	0,2	2	10 0530 28 20	4 007371 044486	
Öl:						
5,0	19,0	0,2	2	10 0531 28 20	4 007371 044493	



Wiegemesser, 2-schneidig

mincing knife double
hachoir berceuse double
mezzaluna 2 lame
cuchillo picar 2 hojas
wiegemes

Klingenlänge cm	inch	Art.-Nr.	EAN	GP
17,0	7	10 0517 28 00	4 007371 044110	



Gemüseschäler »2in1«

vegetable peeler
éplucheur végétale
pela verdura
pela verduras
dunschiller

Klingenlänge cm	inch	Art.-Nr.	EAN	GP
4,5	2	10 0520 28 00	4 007371 041720	

mit zwei Pendelklingen: Sparschäler & Julienne-Schäler,
für Links- und Rechtshänder

36 Stück im attraktiven Verkaufs-Display



Gemüseschäler, längs

vegetable peeler
éplucheur végétale
pela verdura
pela verduras
dunschiller

Klingenlänge cm	inch	Art.-Nr.	EAN	GP
5,0	2	10 0521 28 00	4 007371 057226	

für Links- und Rechtshänder
Gesamtlänge 16,5 cm



Gemüseschäler, quer

vegetable peeler
éplucheur végétale
pela verdura
pela verduras
dunschiller

Klingenlänge cm	inch	Art.-Nr.	EAN	GP
5,0	2	10 0522 28 00	4 007371 057233	

für Links- und Rechtshänder
Gesamtlänge 12,0 cm



Spargel

Vom handlichen Spargelschäler für das mühelose Vorbereiten über Spargelkocher zur perfekten Zubereitung des Gemüses bis zum Butterpfännchen mit passendem Rechaud für das stilechte Anrichten bei Tisch lässt das KÜCHENPROFI – Sortiment keine Wünsche offen.



Spargel

Edelstahl rostfrei / stainless steel

Spargel



Spargelkocher »Siena«

asparagus pot
cuit-vapeur à asperges
cuoci asparagi
hervidor espárragos
aspergepan

Ø cm	Höhe cm	Inhalt ltr.	inch	Art.-Nr.	EAN
16,0	23,0	4,0	6½	10 3001 28 16	4 007371 027892

mit Edelstahleinsatz, Sandwichboden, Glasdeckel
geeignet für Elektro, Gas, Glaskeramik, Induktion



Spargelschäler

asparagus peeler
éplucheur à asperges
pela asparagi
pela espárragos
aspergeschiller

Länge cm	inch	Art.-Nr.	EAN
16,0	6½	10 3002 28 00	4 007371 033589

auch für Möhren geeignet / für Links- und Rechtshänder
24 Stück im attraktiven Verkaufs-Display



Gemüse-/ Spargelschäler mit 2 Klingen

asparagus peeler
éplucheur à asperges
pela asparagi
pela espárragos
aspergeschiller

Länge cm	inch	Art.-Nr.	EAN
17,0	6½	10 3003 28 00	4 007371 058971

auch für Möhren geeignet / für Links- und Rechtshänder
24 Stück im attraktiven Verkaufs-Display



><<>
Kurz Kurz Design



Butterpfännchen

saucepan
casserole à beurre
pentolino per burro
cazo salsa
boterpannetje

Ø cm	Höhe cm	Inhalt ltr.	inch	Art.-Nr.	EAN
10,0	4,2	0,2	4	10 3578 28 10	4 007371 014205

Rechaud für Butterpfännchen

warmer for saucepan
rechaud pour casserole
fornello per pentolino
calentador para cazo salsa
rechaud voor boterpannetje

Ø cm	Höhe cm	Ø inch	Art.-Nr.	EAN
10,0	6,0	4	10 3600 28 00	4 007371 019484



Butterpfännchen

butter melter
casserole à beurre
pentolino per burro
cazo salsa
boterpannetje

Ø cm	Inhalt ltr.	Ø inch	Art.-Nr.	EAN
10,0	0,25	4	23 7000 28 10	4 007371 051569
12,0	0,5	4	23 7000 28 12	4 007371 051576

mit Innenskala
geeignet für **Induktion**
(abhängig vom Mindestdurchmesser der Topferkennung)

GP = Produkt in farbigem Geschenkkarton

KE = auf Karte mit Euroloch

Reibenvielfalt

Wer Wert auf eine gesunde, frische Ernährung legt, benötigt auch gute Küchengeräte. Das Reiben-Sortiment von KÜCHENPROFI bietet unentbehrliche Helfer für schmackhafte Gerichte. Ob fein geraspelte Rohkost, gleichmäßige Kartoffelscheiben oder geriebener Käse für den Auflauf – KÜCHENPROFI wird jedem Anspruch gerecht.



Reiben

Edelstahl rostfrei / stainless steel

Reibenvielfalt



Reibe »Quadro«

box grater, 4-sided
râpe à 4 faces
grattugia quadra
rallador 4 ángulos
4-kantige rasp

Höhe cm	inch	Art.-Nr.	EAN
18,5	7½	10 0440 28 00	4 007371 043861

mit Grob-, Fein- und Kronenreibe sowie Gurkenhobel



Reibe »Quadro«

box grater, 4-sided
râpe à 4 faces
grattugia quadra
rallador 4 ángulos
4-kantige rasp

Höhe cm	inch	Art.-Nr.	EAN
25,0	10	10 0445 28 00	4 007371 043878

mit Grob-, Fein- und Kronenreibe sowie Gurkenhobel



4-Kant-Reibe »Profi«

box grater 4-sided
râpe à 4 faces
grattugia quadra
rallador 4 ángulos
4-kantige rasp

Höhe cm	inch	Art.-Nr.	EAN
24,0	4	10 0509 28 00	4 007371 053662

Zester fein/grob, Raspel, Grobreibe und Gurkenhobel
Messerscharfe Klingen durch moderne Ätztechnik



4-Kant-Reibe

small box grater, 4-sided
râpe à 4 faces
grattugia quadra
rallador 4 ángulos
4-kantige rasp

Höhe cm	inch	Art.-Nr.	EAN
21,5	8½	10 0510 28 00	4 007371 025065

mit Grob-, Fein- und Kronenreibe sowie Gurkenhobel



Jumbo 4-Kant-Reibe

large box grater, 4-sided
râpe à 4 faces géante
grattugia jumbo quadra
rallador 4 ángulos jumbo
jumbo 4-kantige rasp

Höhe cm	inch	Art.-Nr.	EAN
23,5	9½	10 0512 28 00	4 007371 026574

mit Grob-, Fein- und Kronenreibe sowie Gurkenhobel



GP = Produkt in farbigem Geschenkkarton



KE = auf Karte mit Euroloch

Reiben

Edelstahl rostfrei / stainless steel

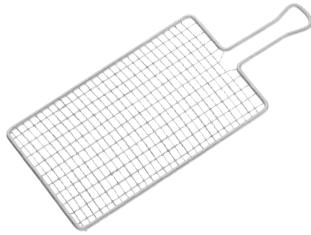

Kartoffelreibe

potato grater
râpe a pomme de terre
grattugiapatate
rallador patatas
ardappelrasp

L/B cm	inch	Art.-Nr.	EAN
32,0 x 13,0	12½ x 5	10 2008 28 00	4 007371 039406



Gurkenhobel »Fix«, hochwertiger Kunststoff

cucumber slicer
râpe à concombres
grattugia cetriolo
cortador pepinos
komkommerrasp

L/B cm	inch	Art.-Nr.	EAN
27,5 x 11,0	11 x 4½	10 2013 22 00	4 007371 045902

mit extra scharfer Klinge und rutschfester Auflage



Zweifachhobel

double slicer
rabot légumes
affetta verdure
corta verduras
groente schaaaf

L/B cm	inch	Art.-Nr.	EAN
33,0 x 12,0	13 x 4¾	13 1087 22 00	4 007371 052986

für Scheiben und Julienne



Gemüsehobel »Professional«

vegetable slicer
râpe à légumes
affetta
cortador vegetales
groentenschaaf

L/B/H cm	inch	Art.-Nr.	EAN
43,5 x 11,5 x 14,0	17 x 4½ x 5½	09 0043 10 00	4 007371 056052

mit Resthalter
5 Schneideinsätze für Scheiben (1,5 mm / 2,5 mm / 3,5 mm) und Streifen (3,5 mm / 7,5 mm)
rutschfeste FüÙe für sicheres Arbeiten

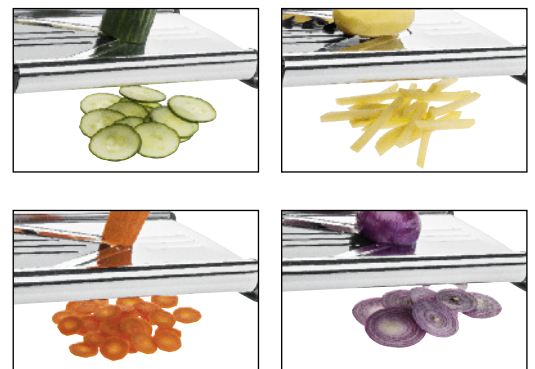

Reiben

Edelstahl rostfrei / stainless steel



- spülmaschinenfest
- Design: Ralph Krämer



Reibbild, Darstellung 1:1

Reibe fein

fine grater
râpe à fin
grattugia, fine
rallador en fino
rasp, fijn



Messerscharfe Klingen durch moderne Ätztechnik
Rutschfester Silikonfuß für sicheren Stand

Art.-Nr.	EAN
12 3001 28 00	4 007371 050760

L/B/H cm	inch
32,0 x 6,5 x 1,5	12½ x 2½ x ⅝

Reibfläche: 13,5 x 5,5 cm



Reibbild, Darstellung 1:1

Reibe grob

coarse grater
râpe à gros
grattugia, grosso
rallador en grueso
rasp, grof



Messerscharfe Klingen durch moderne Ätztechnik
Rutschfester Silikonfuß für sicheren Stand

Art.-Nr.	EAN
12 3002 28 00	4 007371 050777

L/B/H cm	inch
32,0 x 6,5 x 1,5	12½ x 2½ x ⅝

Reibfläche: 13,5 x 5,5 cm

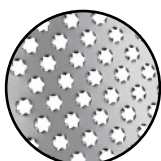

Reibbild, Darstellung 1:1

Kronenreibe

crown grater
râpe couronnes
grattugia corona
rallador corona
kroon rasp



Messerscharfe Klingen durch moderne Ätztechnik
Rutschfester Silikonfuß für sicheren Stand

Art.-Nr.	EAN
12 3003 28 00	4 007371 050784

L/B/H cm	inch
32,0 x 6,5 x 1,5	12½ x 2½ x ⅝

Reibfläche: 13,5 x 5,5 cm



**Restehalter
zur Reiben-Serie
»Classic«**

hand guard
poussoir-garde
fermaresti
empujador de seguridad
resthouder

Art.-Nr.	EAN
12 3000 10 00	4 007371 050753



- spülmaschinenfest
- Design: Ralph Krämer

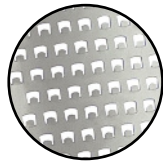

Reibbild, Darstellung 1:1



Messerscharfe Klingen durch moderne Ätztechnik
Rutschfester Silikonfuß für sicheren Stand

Zester fein

fine zester
zesteur à fin
grattugia fine
rallador zester, fino
rasp, fijn

Art.-Nr.	EAN
12 3005 28 00	4 007371 050807

L/B/H cm	inch
32,0 x 6,5 x 1,5	12½ x 2½ x ⅝

Reibfläche: 13,5 x 5,5 cm

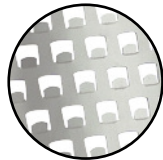

Reibbild, Darstellung 1:1



Messerscharfe Klingen durch moderne Ätztechnik
Rutschfester Silikonfuß für sicheren Stand

Zester grob

coarse zester
zesteur à gros
grattugia grossa
rallador zester, grueso
rasp, grof

Art.-Nr.	EAN
12 3006 28 00	4 007371 050814

L/B/H cm	inch
32,0 x 6,5 x 1,5	12½ x 2½ x ⅝

Reibfläche: 13,5 x 5,5 cm



Restehalter zur Reiben-Serie »Classic«

hand guard
poussoir-garde
fermaresti
empujador de seguridad
resthouder

Art.-Nr.	EAN
12 3000 10 00	4 007371 050753

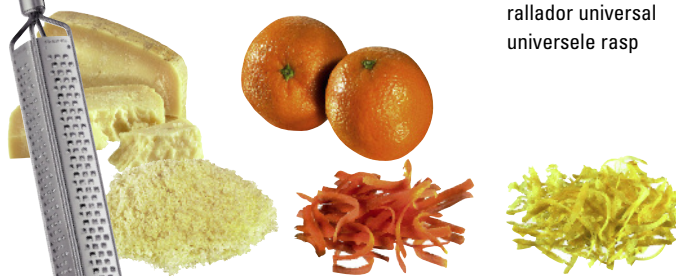

Messerscharfe Klingen durch moderne Ätztechnik
Rutschfester Silikonfuß für sicheren Stand

Multi-Reibe »Parma Gourmet«

all-purpose grater
râpe universelle
grattugia universale
rallador universal
universele rasp

Art.-Nr.	EAN
12 3007 28 00	4 007371 057905

Länge cm	inch
40,0	16⅝

Kronenreibe, Zester fein, Zester grob
Reibfläche: 22,0 x 3,0 cm

Reiben

Edelstahl rostfrei / stainless steel



■ spülmaschinenfest
■ Design: Ralph Krämer

PARMA Reiben & more



Reibbild, Darstellung 1:1



Messerscharfe Klingen durch moderne Ätztechnik
Rutschfester Silikonfuß für sicheren Stand

Zester fein

fine zester
zesteur à fin
grattugia fine
rallador zester, fino
rasp, fijn

Art.-Nr.	EAN
12 3105 28 00	4 007371 050838

L/B/H cm	inch
40,0 x 3,5 x 1,5	15½ x 1⅓ x ⅝

Reibfläche: 22,0 x 3,0 cm



Reibbild, Darstellung 1:1



Messerscharfe Klingen durch moderne Ätztechnik
Rutschfester Silikonfuß für sicheren Stand

Zester grob

coarse zester
zesteur à gros
grattugia grossa
rallador zester, grueso
rasp, grof

Art.-Nr.	EAN
12 3106 28 00	4 007371 050845

L/B/H cm	inch
40,0 x 3,5 x 1,5	15½ x 1⅓ x ⅝

Reibfläche: 22,0 x 3,0 cm

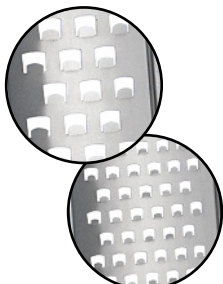

Reibbild, Darstellung 1:1



Messerscharfe Klingen durch moderne Ätztechnik
Rutschfester Silikonfuß für sicheren Stand

Zester fein + grob

fine / coarse zester
zesteur à fin / gros
grattugia fine / grossa
rallador zester fino / grueso
rasp, fijn / grof

Art.-Nr.	EAN
12 3107 28 00	4 007371 050852

L/B/H cm	inch
40,0 x 3,5 x 1,5	15½ x 1⅓ x ⅝

Reibfläche: 22,0 x 3,0 cm



Restehalter zur Reiben-Serie »Gourmet«

hand guard
poussoir-garde
fermaresti
empujador de seguridad
resthouder

Art.-Nr.	EAN
12 3100 10 00	4 007371 050821

GP = Produkt in farbigem Geschenkkarton

KE = auf Karte mit Euroloch



■ spülmaschinenfest

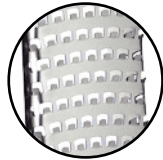

Reibbild, Darstellung 1:1

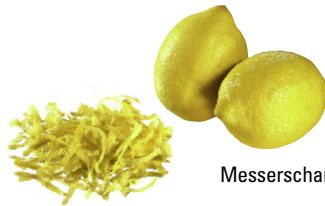

Messerscharfe Klingen durch moderne Ätztechnik

Zester fein

fine zester
zesteur à fin
grattugia fine
rallador zester, fino
rasp, fijn

Art.-Nr.	EAN
12 3205 28 00	4 007371 050869

L/B/H cm	inch
33,0 x 3,5 x 1,5	15½ x 1¼ x ¾

Reibfläche: 20,5 x 2,5 cm



Reibbild, Darstellung 1:1



Messerscharfe Klingen durch moderne Ätztechnik

Zester grob

coarse zester
zesteur à gros
grattugia grossa
rallador zester, grueso
rasp, grof

Art.-Nr.	EAN
12 3206 28 00	4 007371 050876

L/B/H cm	inch
33,0 x 3,5 x 1,5	15½ x 1¼ x ¾

Reibfläche: 20,5 x 2,5 cm

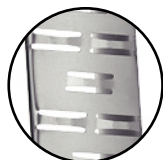

Reibbild, Darstellung 1:1



Messerscharfe Klingen durch moderne Ätztechnik

Raspel

rasp medium ribbon
râpe
grattugia media
rallador medio
rasp medium

Art.-Nr.	EAN
12 3208 28 00	4 007371 050883

L/B/H cm	inch
33,0 x 3,5 x 1,5	15½ x 1¼ x ¾

Reibfläche: 20,5 x 2,5 cm



Reiben

Edelstahl rostfrei / stainless steel

Reibenvielfalt



Standreibe, klappbar

collapsible grater
râpe pliante
grattugia a scala, apribile
rallador plegable
staande rasp, inklapbaar

L/B/H cm	inch	Art.-Nr.	EAN	
24,0 x 8,0 x 2,5	9½ x 3 x 1	12 3500 28 00	4 007371 050890	

messerscharfe Klingen durch moderne Ätztechnik
rutschfeste Silikonfüße für sicheren Stand

Reibfläche: 15,5 x 8 cm



Gurkenhobel »Profi«

cucumber slicer
râpe à concombres
grattugia cetriolo
cortador pepinos
komkommerrasp

L/B/H cm	inch	Art.-Nr.	EAN	
27,0 x 9,5 x 2,0	10½ x 3¾ x ¾	12 3604 28 00	4 007371 052771	

Reibfläche: 15,5 x 8 cm



Universalreibe »Profi«

all-purpose grater
râpe universelle
grattugia universale
rallador universal
universele rasp

L/B/H cm	inch	Art.-Nr.	EAN	
27,0 x 9,5 x 2,0	10½ x 3¾ x ¾	12 3610 28 00	4 007371 052795	

Reibfläche: 15,5 x 8 cm



Finger-Schneidschutz

finger protector
protège-doigts
proteggi dita
protector para los dedos
vinger-snijbeschermer

L/B/H cm	inch	Art.-Nr.	EAN	
19,0 x 6,5 x 2,5	7½ x 2½ x 1	12 2900 28 00	4 007371 055086	

18 Stück im attraktiven Verkaufs-Display



Muskat-/Gewürzreibe, mit Behälter

nutmeg/spice grater
râpe à épices
grattugia per spezie
rallador de especias
muskaat-kruidenrasp

L/B/H cm	inch	Art.-Nr.	EAN	
7,5 x 5,0 x 3,0	3 x 2 x 1	12 3550 28 00	4 007371 051866	

24 Stück im attraktiven Verkaufs-Display

Reiben

Edelstahl rostfrei / stainless steel

Käsereibe

cheese grater
râpe à fromage
grattugia per formaggio
rallador queso
kaasrasp



Länge cm	inch	Art.-Nr.	EAN
20,0	7¾	13 1021 28 00	4 007371 03226 1

Käsereibe elektrisch, mit 2 Trommeln

cheese grater electric
râpe à fromage électrique
grattugia per formaggio elettrica
rallador de queso eléctrico
electrische kaasrasp



L/B/H cm	inch	Art.-Nr.	EAN
26,5 x 9,5 x 10,5	10½ x 3¾ x 4	13 9000 14 00	4 007371 060707
26,5 x 9,5 x 10,5	10½ x 3¾ x 4	13 9000 77 00	4 007371 060714

für Parmesan, andere Hartkäsesorten, Nüsse und Schokolade
Inklusive Akku, Ladegerät, 2 Reibtrommeln und Bedienungsanleitung

Technische Daten

Ladegerät:

Eingang: 230 V ~ 50 Hz / Ausgang: 5 Vdc 300 mA

Akku: 3,6 Vdc 800 mAh



Timer

Im Alltagsstress verliert man schnell den Überblick. Doch jetzt verpassen Sie den richtigen Moment nicht mehr. Sei es das sonntägliche Frühstücksei oder der grüne Tee, die mit den zuverlässigen Timern immer perfekt gelingen.



Küchentimer



Timer »Peppino«

timer
minuteur
contaminuti
timer
kookwekker

Ø cm	Höhe cm	Ø inch	Art.-Nr.	EAN
6,0	10,0	2½	10 0905 00 00	4 007371 027380

60 Minuten-Timer



Timer »Pluto«

timer
minuteur
contaminuti
timer
kookwekker

Ø cm	Höhe cm	Ø inch	Art.-Nr.	EAN
6,5	6,0	2½	10 0919 28 00	4 007371 050111

60 Minuten-Timer



Timer »Planet«

timer
minuteur
contaminuti
timer
kookwekker

Ø cm	Höhe cm	Ø inch	Art.-Nr.	EAN
9,5	6,0	3¾	10 0923 28 00	4 007371 045728

60 Minuten-Timer



Timer »Planet«

timer
minuteur
contaminuti
timer
kookwekker

Ø cm	Höhe cm	Ø inch	Art.-Nr.	EAN
9,5	6,0	3¾	10 0923 10 00	4 007371 060042

60 Minuten-Timer



Timer »Planet«

timer
minuteur
contaminuti
timer
kookwekker

Ø cm	Höhe cm	Ø inch	Art.-Nr.	EAN
9,5	6,0	3¾	10 0923 14 00	4 007371 060059

60 Minuten-Timer



Timer »Planet«

timer
minuteur
contaminuti
timer
kookwekker

Ø cm	Höhe cm	Ø inch	Art.-Nr.	EAN
9,5	6,0	3¾	10 0923 22 00	4 007371 060066

60 Minuten-Timer

Küchentimer

Timer und andere Helfer



Timer »Egg«

timer
minuteur
contaminuti
timer
kookwekker

Ø cm	Höhe cm	Ø inch	Art.-Nr.	EAN	
6,0	8,0	3	10 0924 28 00	4 007371 045889	

60 Minuten-Timer



Timer »Egg«

timer
minuteur
contaminuti
timer
kookwekker

Ø cm	Höhe cm	Ø inch	Art.-Nr.	EAN	
6,0	8,0	3	10 0924 10 00	4 007371 055574	

60 Minuten-Timer



Timer »Egg«

timer
minuteur
contaminuti
timer
kookwekker

Ø cm	Höhe cm	Ø inch	Art.-Nr.	EAN	
6,0	8,0	3	10 0924 11 00	4 007371 055581	

60 Minuten-Timer



Timer »Egg«

timer
minuteur
contaminuti
timer
kookwekker

Ø cm	Höhe cm	Ø inch	Art.-Nr.	EAN	
6,0	8,0	3	10 0924 14 00	4 007371 055598	

60 Minuten-Timer



Timer »Egg perfect«

timer
minuteur
contaminuti
timer
kookwekker

L/ B cm	inch	Art.-Nr.	EAN	
6,0 x 4,0	2½ x 1½	10 0925 00 00	4 007371 042017	

18 Stück im attraktiven Verkaufs-Display



Küchentimer

Sanduhr »Tea Time«, 3-teilig



sandglass
sablier
clessidra
reloj
sandloper

Höhe cm	inch	Art.-Nr.	EAN
8,0	3	10 0926 00 00	4 007371 051552

für 3 Minuten (grün), 5 Minuten (schwarz) und 7 Minuten (rot)

Digitaltimer »4times«



timer
minuteur
contaminuti
timer
kookwekker

L/B/H cm	inch	Art.-Nr.	EAN
8,5 x 8,5 x 4,0	3 3/8 x 3 3/8 x 1 1/2	10 0927 00 00	4 007371 051637

überwacht bis zu 4 verschiedene Zeiten

Sand / Eieruhr, 3-teilig



sandglass
sablier
clessidra
reloj
sandloper

Höhe cm	inch	Art.-Nr.	EAN
8,0	3	10 0928 00 00	4 007371 058315

für 4 Minuten (gelb), 5 Minuten (schwarz) und 6 Minuten (orange)



Braten







Zartes Fleisch, würzige Marinade und cremige Saucen – das sind die Zutaten für einen köstlichen Braten.

Die nötigen Accessoires für ein perfektes Ergebnis kommen von KÜCHENPROFI – Rouladenklammern oder Küchengarn für eine schöne Form, Bratenthermometer für die richtige Kerntemperatur und Ofenhandschuhe für ausreichenden Schutz.

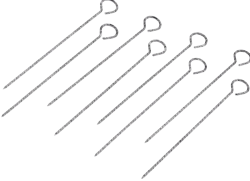
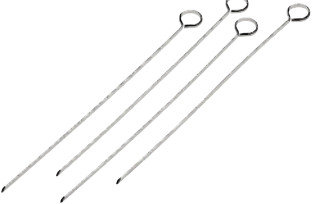

Braten

Edelstahl rostfrei / stainless steel

	Rouladenklammern, 6 Stück im Set meat clamp pince à roulades ganci per involtini pinzas para rollos de carne rellenos rolladeklemmen	L/B cm 10,0 x 4,0	inch 4 x 1½	Art.-Nr. 09 2401 28 06	EAN 4 007371 057023
	Rouladenringe, 6 Stück im Set roulade rings boucle à roulades anello per involtini rollas de carne rellenos rollade ring	Ø cm 4,5 – 5,5	Ø inch 1¾	Art.-Nr. 09 2402 28 06	EAN 4 007371 057035
	Rouladennadeln, 10 Stück im Set roulade needles aiguilles à roulades agni per involtini aros fijadores para rollos de carne rollade naalden	Länge cm 10,0	inch 4	Art.-Nr. 09 2403 28 10	EAN 4 007371 057042
	Gourmetspieße, 4 Stück im Set gourmet skewers broches gourmet spiedi per gourmet pinchos para gourmet gourmet spies	Länge cm 20,5	inch 8	Art.-Nr. 09 2404 28 04	EAN 4 007371 057059
	Spicknadel larding needle lardoire ago per lardellare mechador lardeernaald	Länge cm 19,5	inch 7½	Art.-Nr. 09 2405 28 00	EAN 4 007371 058025
	Kordelbox »Küchengarn«, mit Schneidevorrichtung cord box cordelette en boîte spago per la cucina caja hilo cocina keukengaren	Ø cm Höhe cm 7,0 7,5	Ø inch 2½	Art.-Nr. 09 2500 00 00	EAN 4 007371 040327
inklusive 50m lebensmittelechtem Garn					
2 Ersatzrollen Küchengarn					
		2 x 50 m	2 x 19½	09 2550 00 02	EAN 4 007371 034999
	Kordelbox »Küchengarn«, mit Schneidevorrichtung cord box cordelette en boîte spago per la cucina caja hilo cocina keukengaren	Ø cm Höhe cm 8,0 8,0	Ø inch 3	Art.-Nr. 09 2550 00 00	EAN 4 007371 031370
inklusive 50m lebensmittelechtem Garn					
2 Ersatzrollen Küchengarn					
		2 x 50 m	2 x 19½	09 2550 00 02	EAN 4 007371 034999
	Kordelbox »Wurstgarn«, mit Schneidevorrichtung cord box cordelette en boîte spago per la cucina caja hilo cocina keukengaren	Ø cm Höhe cm 8,0 8,0	Ø inch 3	Art.-Nr. 09 2560 00 00	EAN 4 007371 050203
inklusive 50m lebensmittelechtem Garn					
2 Ersatzrollen Wurstgarn					
		2 x 50 m	2 x 19½	09 2560 00 02	EAN 4 007371 050517

 GP = Produkt in farbigem Geschenkkarton

 KE = auf Karte mit Euroloch

Braten

Edelstahl rostfrei / stainless steel

Braten

Fett-Trennkanne



fat separator jug
verseuse graduée gras/maigre
versatore grasso/magro
jarra separadora de grasas
kan met vetafscheider

Ø cm	Höhe cm	Inhalt ltr.	inch	Art.-Nr.	EAN
11,0	16,0	1,0	4½	10 1236 28 00	4 007371 047623

Edelstahl/Glas

Ofenhandschuh kurz, 2 Stück im Set



oven gloves
gants de four
guanti da forno
guantes para horno
ovenhandschoenen

Länge cm	inch	Art.-Nr.	EAN
23,0	9	10 6000 22 23	4 007371 057943

waschbar bei 40°C, geschmeidig, hitzebeständig und schwer entflammbar, mit Baumwolle gefüttert. 350°C Hitzeschutz

Ofenhandschuh lang, 2 Stück im Set



oven gloves
gants de four
guanti da forno
guantes para horno
ovenhandschoenen

Länge cm	inch	Art.-Nr.	EAN
39,0	15½	10 6000 22 39	4 007371 057950

waschbar bei 40°C, geschmeidig, hitzebeständig und schwer entflammbar, mit Baumwolle gefüttert. 350°C Hitzeschutz

Topfhandschuh »Apollo«



oven mitt
gant de cuisine
quanto forno
manopla horno
keukenwant

Länge cm	inch	Art.-Nr.	EAN
30,0	11¾	10 6100 00 00	4 007371 032278

hitzeisoliert, auch für Grill und Backofen

Braten- / Gewürzspritze



baster set
seringue à épices
pompetta per arrosti
set para rustidos
kruiden-injector voor braadvlees

Länge cm	inch	Art.-Nr.	EAN
31,0	12	10 6300 28 00	4 007371 034272

inklusive Reinigungsbürste

Gewürz- & Marinaden- spritze »Spicy«



gourmet marinade injector
seringue à épices
siringa per arrosti
jeringa para rustidos
pipet/bedruijspuit

Länge cm	inch	Art.-Nr.	EAN
25,0	10	10 6360 28 00	4 007371 057998

inklusive 2 Nadeln, 3,5 mm und 5 mm

Thermometer

Edelstahl rostfrei / stainless steel

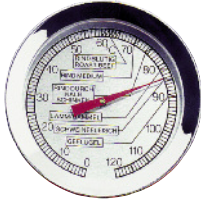

Braten-Thermometer

roast thermometer
thermomètre à rôti
termometro per arrostiti
termómetro para asados
braadthermometer

Ø cm	Höhe cm	Ø inch	Art.-Nr.	EAN
11,0	5,5	4½	10 6500 28 00	4 007371 037044

Skala: 0° – 120°C

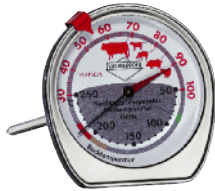

Kombi-Thermometer, Braten/Ofen

roast / oven thermometer
thermomètre pour le four / à rôti
termometro per forno / arrostiti
termómetro para el horno / asados
oven / braad thermometer

L/B/H cm	inch	Art.-Nr.	EAN
7,0 x 7,5 x 14,0	2¾ x 3 x 5½	10 6505 28 00	4 007371 053099

Skala Braten: 30°C – 100°C
Skala Ofen: 50°C – 250°C
Messfühler: 11,5 cm



Backofen-Thermometer

oven thermometer
thermomètre pour le four
termometro per forno
termómetro para el horno
oven thermometer

Ø cm	Ø inch	Art.-Nr.	EAN
7,5	3	10 6510 28 00	4 007371 041997

Skala: 50° – 300°C,
auch zum Hängen geeignet



Kühlschrank-Thermometer

refrigerator thermometer
thermomètre de réfrigérateur
termometro per frigorifero
termómetro para la nevera frigorifera
koelkast thermometer

Ø cm	Ø inch	Art.-Nr.	EAN
7,5	3	10 6520 28 00	4 007371 042000

Skala: -30° bis + 30°C, auch für Gefrierschrank
auch zum Hängen geeignet



Digitales Braten-Thermometer »Easy«

roast thermometer
thermomètre à rôti
termometro per arrostiti
termómetro para asados
braadthermometer

L/B/H cm	inch	Art.-Nr.	EAN
6,5 x 9,5 x 2,5	2½ x 3¾ x 1	10 6504 00 00	4 007371 058759

Umschaltbar °C/°F
Messbereich: 0°C bis 250°C
inklusive Batterie und Bedienungsanleitung



Digitales Braten-Thermometer »Profi«

roast thermometer
thermomètre à rôti
termometro per arrostiti
termómetro para asados
braadthermometer

L/B/H cm	inch	Art.-Nr.	EAN
7,0 x 1,5 x 11,5	2¾ x ½ x 4½	10 6568 00 00	4 007371 052108

mit Funkübertragung (Reichweite bis 30m)



Frittier-Thermometer

deep fry thermometer
thermomètre pour le friture
termometro per friggere
termómetro para freír
frituurthermometer

Ø cm	L cm	Ø inch	Art.-Nr.	EAN
5,5	21,0	2	10 6508 28 00	4 007371 060691

Braten

Kaffee- und Tee-Accessoires

Dampfender Kaffee mit einer Haube aus cremigem Milchschaum oder doch lieber eine Tasse Tee?

Egal wie Sie sich entscheiden, immer garantieren hochwertige Materialien, ansprechende Designs und langlebige Verarbeitung vollendeten Genuss.



Tea-Boy Pinguin

mit Präzisions-Timer

Höhe cm

inch

Art.-Nr.

EAN



20,0

8

31 1000 00 00



hebt nach Ablauf der eingestellten Zeit den Teebeutel aus der Tasse
Funktion ohne Batterien



Einfachste Bedienung:



1. Teebeutel oder Tee-Ei einhängen und über der Tasse mit heißem Wasser positionieren.
Timer bis zum Anschlag aufziehen, dabei senkt sich der Schnabel automatisch.

2. Gewünschte Zeit einstellen.

3. Der Schnabel hebt sich automatisch nach Ablauf der Zeit, ein Signal ertönt.

Viel Spaß beim Teegenuss!



Scheiben-Zitronenpresse

lemon slice squeezer
presse citron en tranche
spremiagrumi
prensa limones
citronschiifjes pers

Höhe cm

inch

Art.-Nr.

EAN

9,0 x 7,0

3½ x 2¾

10 1518 28 00



GP = Produkt in farbigem Geschenkkarton



KE = auf Karte mit Euroloch

Tee-Accessoires

Edelstahl rostfrei / stainless steel

	Teefilter für Tassen	Ø cm	Höhe cm	Ø inch	Art.-Nr.	EAN	
	tea strainer passe-thé passino tè colador de té theezeef	7,5	6,5	3	10 4500 28 00	4 007371 040754	

	Teesiebe, 3-teilig				Art.-Nr.	EAN	
	tea strainer, 3 pcs. passe-thé, 3 pcs. passino tè, 3 pz. colador de té, 3 pzs. theezeef, 3 stuks				10 4501 28 00	4 007371 037693	
Ø in den Größen: 50 mm, 65 mm, 75 mm 2 inch, 2,5 inch, 3 inch							

	Tee-/Gewürzzange	Ø cm		Ø inch	Art.-Nr.	EAN	
	tea/spice tongs pince à thé/épices pinza té/spezie pinzas té/especies thee/kruidentang	4,5		1½	10 4502 28 04	4 007371 025126	
		5,0		2	10 4502 28 05	4 007371 025133	
		6,5		2½	10 4502 28 06	4 007371 025140	

	Tee-/Gewürzkugel	Ø cm		Ø inch	Art.-Nr.	EAN	
	tea ball boule à thé/épices porta tè/spezie bola de té/especies thee/kruidenbol	5,0		2	10 4503 28 05	4 007371 029643	
		6,5		2½	10 4503 28 06	4 007371 029650	

	Teesieb »Ceylon«	Ø cm		Ø inch	Art.-Nr.	EAN	
	tea ball boule à thé porta tè bola de té theebol	6,0		2½	10 4506 28 00	4 007371 041423	



	Teebeutel-Zange	Länge cm		inch	Art.-Nr.	EAN	
	tea bag tongs pince à sachet de thé pinza per bustina di tè pinzas para bolso de té theezakjes tang	14,0		5½	10 4509 28 00	4 007371 043892	

	Tee-Sieb »Ente«	Ø cm	Höhe cm	Ø inch	Art.-Nr.	EAN	
	tea strainer passe-thé passino tè colador de té theezeef	5,0	8,0	2	10 4511 00 00	4 007371 053499	
		Kunststoff				24 Stück im attraktiven Verkaufs-Display	

= Produkt in farbigem Geschenkkarton

= auf Karte mit Euroloch

Tee-Accessoires

Edelstahl rostfrei / stainless steel



Teebeutel-Klammer, 2 Stück im Set

tea bag clips
clip pour filtre à thé
clip per filtro di carta per tè
bolsa de filtro de té
thee filter houder

Länge	inch	Art.-Nr.	EAN
17,0	6½	10 4519 28 00	4 007371 060073

ideal für Tassen und Kannen



Teebeutel-Halter, 2 Stück im Set

tea bag holder
support de sachet de thé
sostegno per bustine da tè
soporto para la bolsa de té
theezakjeshouder

Länge cm	inch	Art.-Nr.	EAN
16,0	6	10 4520 28 00	4 007371 059282

Design: Matthias Lehr



Profi-Teesieb

tea strainer
passe-thé
passino tè
colador de té
theezeef

Ø cm	Höhe cm	Ø inch	Art.-Nr.	EAN
6,0	7,0	2½	10 4530 28 00	4 007371 042789



Teesieb, schwimmend

tea strainer
passe-thé
passino tè
colador de té
theezeef

Ø cm	Höhe cm	Ø inch	Art.-Nr.	EAN
4,5	8,0	2	10 4531 28 00	4 007371 053815



mit Abtropfbehälter
auch für Kräuter und Gewürze geeignet



Teesieb »Leaf«, 4 Farben sortiert

tea strainer
passe-thé
passinoté
colador de té
theezheef

Ø cm	Höhe cm	Ø inch	Art.-Nr.	EAN
4,0	15,5	1½	10 4535 55 00	4 007371 060462



20 Stück im attraktiven Verkaufs-Display,
Edelstahl/Silikon, farblich sortiert



Stövchen »Ceylon«

tea warmer
rechaud
fornello
calentador
rechaud

Ø cm	Höhe cm	Ø inch	Art.-Nr.	EAN
14,0	4,5	5½	10 4600 28 15	4 007371 057462



inklusive Teelicht

Reber
VLBER
DESIGN



Tee-/Gewürzkugel

tea/spice ball
boule à thé/épices
porta tè/spezie
bola de té/especies
thee/kruidenbol

Ø cm	Ø inch	Art.-Nr.	EAN
6,3	2½	10 9990 28 06	4 007371 035309
10,5	4	10 9990 28 10	4 007371 035286



= Produkt in farbigem Geschenkkarton

= auf Karte mit Euroloch

Teekannen

Edelstahl rostfrei / stainless steel

Teekanne »Malawi«



tea pot, with filter
théière, avec passoire
teiera, con passino
tetera, con colador
theepot, met theezeef

Inhalt ltr.	Art.-Nr.	EAN	
0,8	10 4542 35 00	4 007371 057714	
1,0	10 4543 35 00	4 007371 057721	

Kanne aus Borosilikat-Glas mit Edelstahlfilter

Teekanne »Earl Grey«



tea pot, with filter
théière, avec passoire
teiera, con passino
tetera, con colador
theepot, met theezeef

Inhalt ltr.	Art.-Nr.	EAN	
1,25	10 4560 28 00	4 007371 053136	

Kanne aus Borosilikat-Glas mit Edelstahlfilter

Teegläser »Earl Grey« 2-teilig



tea glasses
verres à thé
bicchiere tè
taza de te de vidrio
theeglazen

Inhalt ltr.	Art.-Nr.	EAN	
0,2	10 4561 28 02	4 007371 054270	

Gläser aus Borosilikat-Glas

Teekanne »Tibet«



tea pot, with filter
théière, avec passoire
teiera, con passino
tetera, con colador
theepot, met theezeef

Inhalt ltr.	Art.-Nr.	EAN	
0,4	10 4570 35 00	4 007371 054720	
0,8	10 4571 35 00	4 007371 054737	
1,2	10 4572 35 00	4 007371 054744	
1,5	10 4573 35 00	4 007371 057967	

Kanne aus Borosilikat-Glas mit Edelstahlfilter

Teekanne »Lotus«



tea pot, with filter
théière, avec passoire
teiera, con passino
tetera, con colador
theepot, met theezeef

Inhalt ltr.	Art.-Nr.	EAN	
0,7	10 4580 28 00	4 007371 054751	
1,2	10 4581 28 00	4 007371 054768	

Kanne aus Borosilikat-Glas mit Edelstahlfilter

Teekanne »Yasmin«



tea pot, with filter
théière, avec passoire
teiera, con passino
tetera, con colador
theepot, met theezeef

Inhalt ltr.	Art.-Nr.	EAN	
1,2	10 4590 10 00	4 007371 057202	

Kanne aus Gusseisen, innen emailliert mit Edelstahlfilter

Teekannen



Teekanne »Farmhouse«, schwarz

tea pot, with filter
théière, avec passoire
teiera, con passino
tetera, con colador
theepot, met theezeeef

Inhalt ltr.	Art.-Nr.	EAN	GP
0,6	10 4700 10 06	4 007371 060097	
1,2	10 4700 10 12	4 007371 060103	
1,6	10 4700 10 16	4 007371 060110	

Kanne aus Steinzeug mit Edelstahlfilter



Teekanne »Farmhouse«, rot

tea pot, with filter
théière, avec passoire
teiera, con passino
tetera, con colador
theepot, met theezeeef

Inhalt ltr.	Art.-Nr.	EAN	GP
0,6	10 4700 14 06	4 007371 060127	
1,2	10 4700 14 12	4 007371 060134	
1,6	10 4700 14 16	4 007371 060141	

Kanne aus Steinzeug mit Edelstahlfilter



Teekanne »Farmhouse«, weiß

tea pot, with filter
théière, avec passoire
teiera, con passino
tetera, con colador
theepot, met theezeeef

Inhalt ltr.	Art.-Nr.	EAN	GP
0,6	10 4700 22 06	4 007371 060158	
1,2	10 4700 22 12	4 007371 060165	
1,6	10 4700 22 16	4 007371 060172	

Kanne aus Steinzeug mit Edelstahlfilter



GP = Produkt in farbigem Geschenkkarton

KE = auf Karte mit Euroloch

Kaffee-Accessoires / Nussknacker

Edelstahl rostfrei / stainless steel

Nussknacker »Classic« verchromt

nut cracker
casse-noix
schiaccianoci
cascanueces
notenkraker



Länge cm	inch	Art.-Nr.	EAN
16,0	6½	08 0900 38 00	4 007371 043359

Nussknacker »Soft touch«

nut cracker
casse-noix
schiaccianoci
cascanueces
notenkraker



Länge cm	inch	Art.-Nr.	EAN
18,5	7½	10 0527 30 00	4 007371 048361

aluminiumbeschichtet
12 Stück im attraktiven Verkaufs-Display

Türkisch Mocca / Aufschäumbecher

foam cup
gobelet mousse
caffetiera
jarra leche
turkse moka



Ø cm	Höhe cm	Inhalt ltr.	inch	Art.-Nr.	EAN
6,5	7,5	0,2	2½	10 1077 28 02	4 007371 025164
8,0	9,0	0,4	3½	10 1077 28 04	4 007371 025171
10,0	11,5	0,7	4½	10 1077 28 07	4 007371 025188

Espressokocher »Napoli«

coffeemaker
cafetière espresso
caffettiera
cafetera
espressokoker



Inhalt	capacity	Art.-Nr.	EAN
3 Tassen	3 cups	18 1000 30 03	4 007371 045377
6 Tassen	6 cups	18 1000 30 06	4 007371 045384

Aluminium

Milchaufschäumer »Latteforte«

Länge cm	Art.-Nr.	EAN
21,0	18 3000 10 00	4 007371 039871

inklusive 2AA Batterien



Praktische Küchenhelfer

Gesunde Küche und schnelle Zubereitung ist kein Widerspruch mehr.
Die praktischen Küchenhelfer lassen die Herzen von Profis und
Genießern höher schlagen.



Praktische Küchenhelfer

Edelstahl rostfrei / stainless steel

	Eisportionierer ice cream scoop cuillère à glace porzionatore gelato cuchara para helado ijs portioneerschep	Ø cm Länge cm 5,0 22,0	Ø inch 8½	Art.-Nr. 10 1950 28 00	EAN 4 007371 023443	
	Dämpfeinsatz, klappbar steaming insert, foldable élément vapeur rabattable cestello a vapore, ribaltabile soporte hervir, plegable stoominzet, inklapbaar	Ø cm 20,0 24,0	Ø inch 8 9½	Art.-Nr. 10 2548 28 20 10 2548 28 24	EAN 4 007371 033688 4 007371 016964	
	Setzei-Ring, Form: Kreis ring for fried egg rond pour œuf sur le plat anello per uovo fritto anillo para huevo frito eierbak-ring	Ø cm 8,5 2 Ringe im Set	Ø inch 3½	Art.-Nr. 10 2600 28 00	EAN 4 007371 038966	
	Setzei-Ring, Form: Blume ring for fried egg rond pour œuf sur le plat anello per uovo fritto anillo para huevo frito eierbak-ring	Ø cm 10,5 2 Ringe im Set	Ø inch 4	Art.-Nr. 10 2610 28 00	EAN 4 007371 038973	
	Setzei-Ring, Form: Herz ring for fried egg rond pour œuf sur le plat anello per uovo fritto anillo para huevo frito eierbak-ring	Ø cm 9,5 2 Ringe im Set	Ø inch 4	Art.-Nr. 10 2620 28 00	EAN 4 007371 038980	
	Trocknerbälle »Dryerballs«, 2er Set dryer balls balles de séchage sfere asciuga biancheria bolas para secadora drogerballen	Ø cm 6,5	Ø inch 2½	Art.-Nr. 05 5000 00 02	EAN 5 1039179 002008	Material: Kunststoff 12 Stück im attraktiven Verkaufs-Display
	Spülbürste »Swashies« dish washing brush brosse pour vaisselle spazzolino cepillo cocina afwasborstel	Höhe cm 21,0	inch 8¼	Art.-Nr. 05 7000 00 00	EAN 4 007371 055116	Material: Kunststoff 12 Stück im attraktiven Verkaufs-Display, farblich sortiert
	Spülbürste »Ente« dish washing brush brosse pour vaisselle spazzolino cepillo cocina afwasborstel	Höhe cm 9,5	inch 3¾	Art.-Nr. 05 7001 16 00	EAN 4 007371 057981	Material: Kunststoff 12 Stück im attraktiven Verkaufs-Display

Praktische Küchenhelfer

Edelstahl rostfrei / stainless steel

Hummerzange

lobster tongs
pince à homard
pinza aragosta
pinzas bogavante
kreeftentang



Länge cm	inch	Art.-Nr.	EAN
18,5	7½	10 3950 28 00	4 007371 043564

Hummergabeln, 4er Set

lobster forks
fourchettes à homard
forchetta aragosta
tenedores bogavante
kreeftenvorkje



Länge cm	inch	Art.-Nr.	EAN
23,0	9	10 3951 28 04	4 007371 043588



Austernhandschuh

oyster glove
gant à huîtres
guanto in acciaio per ostriche
guante protección
oester handschoen



Länge cm	inch	Art.-Nr.	EAN
24,0	9½	10 3970 28 00	4 007371 043564

aus Kettenstahl gefertigt, sehr hochwertig verarbeitet

geeignet für Rechts- und Linkshänder



Abtropfgestell mit Tablett, verchromt

dish draining rack
égouttoir, avec plateau
scolatoio
escurridor platos
afdruiprek met plateau



Art.-Nr.	EAN
10 9035 38 00	4 007371 045674

Tablett: 45,0 x 26,5 / 18 x 10½ inch
Gestell: 42,5 x 34,0 / 17 x 13½ inch

 GP = Produkt in farbigem Geschenkkarton

 KE = auf Karte mit Euroloch



Grillen

Alles für Ihr Grillvergnügen – trendige Grillkörbe oder innovative Hähnchengriller sowie praktische Grillkoffer lassen keine Wünsche offen.

BBQ-Fans werden begeistert sein.



Grillen

Edelstahl rostfrei / stainless steel



Fischgrillzange

BBQ tongs for fish
pince à grill pour poisson
pinza barbeque per pesce
pinzas barbacoa para pescado
vis-grilltang

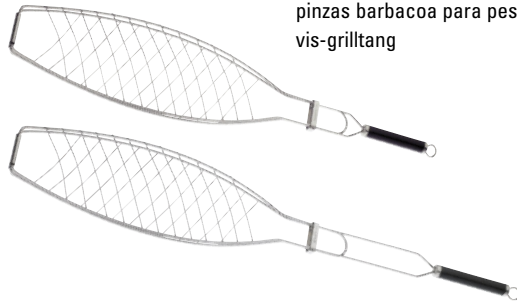



	Länge cm	inch	Art.-Nr.	EAN
kurzer Griff	56,0	22	10 6605 28 00	4 007371 054614
langer Griff	72,0	29	10 6600 28 00	4 007371 037082

Griff aus hochwertigem, hitzeisoliertem Kunststoff, hitzebeständig bis 150°C

Fischgrillzange, für 3 Fische

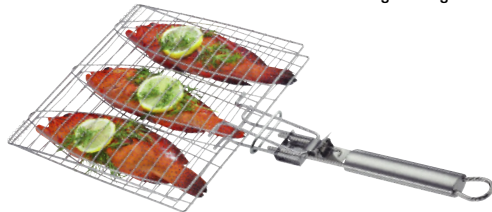
BBQ tongs for fish
pince à grille pour poisson
pinza barbeque per pesce
pinzas barbacoa para pescado
vis-grilltang



L/B/H cm	inch	Art.-Nr.	EAN	
63,0 x 28,0 x 28,0	25 x 11 x 11	10 6606 28 00	4 007371 059244	

mit abnehmbarem Griff
auch für längliche Gemüsescheiben geeignet

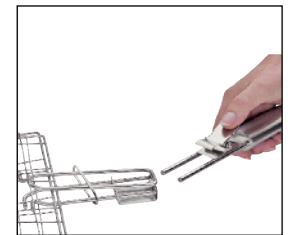

Grill-Gemüsekorb »Flexi«

BBQ basket
panier trouée pour légumes
cestello forata per verdura
cacerola para verdura
groentenschal voor gril



L/B/H cm	inch	Art.-Nr.	EAN	
60,0 x 31,5 x 24,5	7½ x 4½ x 3	10 6607 28 00	4 007371 059251	

mit abnehmbarem Griff
3-fach höhenverstellbar

ideal für Gemüse, Fisch oder Fleisch

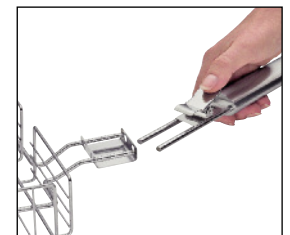

Grillen

Edelstahl rostfrei / stainless steel



Hähnchengriller »BBQ Advantage«

chicken roaster
plat à rôti pour poulet
cuocipollo
asador e pollo
kippengrill



Ø cm	Höhe cm	Ø inch	Art.-Nr.	EAN	GP
18,0	24,0	7	10 3801 28 00	4 007371 053433	

Fassungsvermögen Aromabehälter: 300 ml



Hähnchen Grillkorb

chicken roaster
plat à rôti pour poulet
cuocipollo
asador de pollo
kippengrill



Ø cm	Höhe cm	Ø inch	Art.-Nr.	EAN	GP
20,0	10,0	8	10 6662 28 29	4 007371 056342	

Einsatz im Backofen oder auf dem Grill
Fassungsvermögen Aromabehälter: 250ml



BBQ-Gestell mit Tablett für Hühnerschenkel

chicken leg holder
Grille de cuisson barbecue pour
manchons de poulet
Supporto BBQ per cosce
di pollo con vassoio
Soporte con bandeja
para muslo de pollo
BBQ kippengrill voor drumsticks

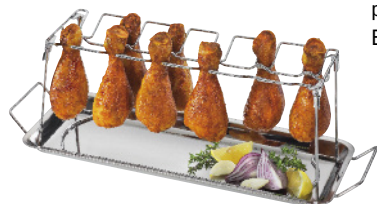

L/B/H cm	inch	Art.-Nr.	EAN	GP
38,0 x 15,5 x 14,5	15 x 6 x 5 7/8	10 6652 28 00	4 007371 060943	

zusammenklappbar
Einsatz im Backofen oder auf dem Grill

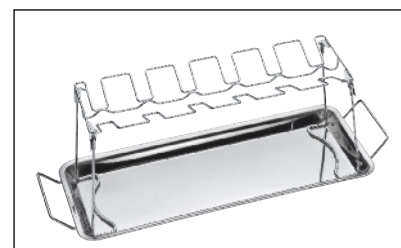

Grill-Kartoffelhalter »Style«

potato rack
support pour pomme de terre
supporto di cottura per patate
soporte para patatas
aardappel houder



L/B/H cm	inch	Art.-Nr.	EAN	GP
43,0 x 9,0 x 5,0	17 x 3 1/2 x 2	10 6658 28 38	4 007371 059237	

gleichzeitiges Grillen von 4 Kartoffeln
auch für Ofenkartoffeln geeignet

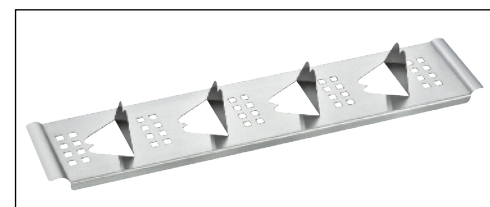

Grillen

Edelstahl rostfrei / stainless steel



Marinaden-Set

marinade set
set de marinade
set per marinare
set para marinar
marinade set

	Höhe cm	Inhalt ltr.	inch	Art.-Nr.	EAN
schw.	20,0	0,3	7¾	09 8500 10 00	4 007371 056809
rot	20,0	0,3	7¾	09 8500 14 00	4 007371 056816

Set besteht aus:
Glas und Silikon-Pinsel



Grillbretter »Smoky«, 2 Stück im Set

grill board
planche à griller
tabla de maderá para barbacoa
tavoleta di legno per grigliata
grill plank

	L/B cm	inch	Art.-Nr.	EAN
S	30,0 x 15,0	11¾ x 6	10 6655 10 02	4 007371 053525
M	35,0 x 17,5	13¾ x 7	10 6656 10 02	4 007371 056373
L	40,0 x 15,0	15¾ x 6	10 6657 10 02	4 007371 054706

Zedernholz; mehrfach wiederverwendbar



BBQ Grillkorb »Style«, hoch

BBQ basket
panier pour légumes
cestello per verdura
cacerola para verdura
groenteschaal voor grill

L/B/H cm	inch	Art.-Nr.	EAN
25,5 x 21,0 x 7,5	10 x 8¼ x 3	10 6659 28 21	4 007371 059213



Grillpfanne / Grill-Gemüsekorb

BBQ basket
panier trouée pour légumes
cestello forata per verdura
cacerola para verdura
groenteschaal voor grill

Ø cm	Höhe cm	Ø inch	Art.-Nr.	EAN
31,0	5,0	12	10 6660 28 00	4 007371 053709
28,0	7,0	11	10 6665 28 00	4 007371 053716



Grillpfanne »Style«

BBQ pan
planche pour grillades
piastra per griglia
bandeja para barbacoa
grillplaat

L/B cm	inch	Art.-Nr.	EAN
25,0 x 16,0	10 x 6	10 6661 28 34	4 007371 056328
34,0 x 23,0	13½ x 9	10 6661 28 43	4 007371 056335

ideal zum Grillen aller kleineren, empfindlichen Lebensmitteln wie Gemüse, Fisch oder Fleisch

Grillen

Edelstahl rostfrei / stainless steel

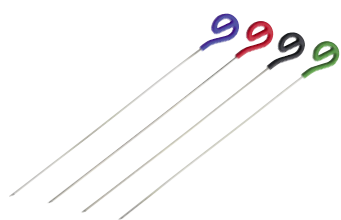

Grillspieße, 4 Stück im Set

BBQ skewers
broche pour grillade
spiedi per la griglia
pinchos barbacoa
grillspies

Länge cm	inch	Art.-Nr.	EAN
30,5	12	10 6260 28 04	4 007371 052092

Griffe aus Silikon, hitzebeständig bis 250°C



KE

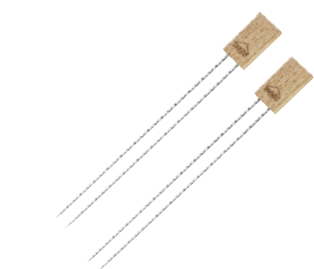

Doppel-Grillspieße, 2 Stück im Set

double BBQ skewers
double broche pour grillade
spiedi doppio per la griglia
pinchos doble barbacoa
dubbel grillspies

Länge cm	inch	Art.-Nr.	EAN
36,0	14	10 6640 28 00	4 007371 054492



KE



BBQ Grillspieße, 2 Stück im Set

BBQ skewers
broche pour grillade
spiedi per la griglia
pinchos barbacoa
grillspies

Länge cm	inch	Art.-Nr.	EAN
47,0	18½	10 6641 28 02	4 007371 056069

Griff aus hochwertigem, hitzeisoliertem Kunststoff
hitzebeständig bis 165°C



KE



Grillspieße »Flexi«, 2 Stück im Set

flexible BBQ skewers
broche flexible pour grillade
spiedi flexible per la griglia
pinchas flexible barbacoa
flexibel grillspies

Länge cm	inch	Art.-Nr.	EAN
77,0	30¾	10 6645 28 00	4 007371 054584



KE



Maiskolbenhalter, 4 Stück im Set

corn holder
pique-épis de maïs
spiedini per pannocchie
pinchos para mazorcas
maiskolf houder

Länge cm	inch	Art.-Nr.	EAN
7,5	3	10 6664 28 04	4 007371 058872



KE



GP = Produkt in farbigem Geschenkkarton



KE = auf Karte mit Euroloch

Grillen

Edelstahl rostfrei / stainless steel



Grill-/Ofenhandschuh lang, 2 Stück im Set

oven gloves
gants de four
guanti da forno
guantes para horno
ovenhandschoenen

Länge cm	inch	Art.-Nr.	EAN	
39,0	15½	10 6000 10 39	4 007371 060431	

waschbar bei 40°C, geschmeidig, hitzebeständig und schwer entflammbar, mit Baumwolle gefüttert. 350°C Hitzeschutz



Brat-/Grillzange, schwarz

all-purpose tongs
pince universelle
pinza per rivoltare
pinzas de barbacoa
grilltang

Länge cm	inch	Art.-Nr.	EAN	
27,0	10½	10 6635 10 27	4 007371 056212	
40,0	15¾	10 6635 10 40	4 007371 056229	

Funktionsteil aus Nylon; hitzebeständig bis 180°C



Brat-/Wende-Pinzette

cooking tweezers
pincette à tourner
pinza per rivoltare
pinzas freír
kookpincet

Länge cm	inch	Art.-Nr.	EAN	
30,5	12	10 6800 28 00	4 007371 038317	



Allzweckzange

all-purpose tongs
pince universelle
pinza universale
pincas universal
universeeltang

Länge cm	inch	Art.-Nr.	EAN	
30,0	12	10 6900 28 00	4 007371 038751	



Silikon-Multizange

all-purpose tongs
pince universelle
pinza per rivoltare
pinzas de cocina
grilltang

Länge cm	inch	Art.-Nr.	EAN	
23,0	9	10 6980 28 23	4 007371 044196	
30,0	12	10 6980 28 30	4 007371 044202	

Funktionsteil mit Silikonbeschichtung; temperaturbeständig bis 220°C

Grillen

Edelstahl rostfrei / stainless steel



Grillen

Hamburgerpresse, 2-teilig

hamburger press
presse à hamburger
stampa per hamburger
prensa hamburguesa
hamburgerpers

Ø cm	Ø inch	Art.-Nr.	EAN	GP
12,0	4¾	10 6666 30 12	4 007371 054713	

Aluminiumguss, beschichtet



Hamburger-Grillzange, für 4 Hamburger

hamburger grilling basket
pince à grillade pour hamburger
griglia per hamburger
pinzas barbacoa para hamburguesas
hamburgergrilltang

Ø / L cm	inch	Art.-Nr.	EAN	GP
11,5 x 55,0	4½ x 18	10 6669 28 00	4 007371 059138	



Fleischbeschwerer

meat press
presse à grillade
peso per la cottura
prensador para carne
vleespers

L/B/H cm	inch	Art.-Nr.	EAN	GP
15,0 x 10,0 x 4,0	6 x 4 x ½	10 6670 28 00	4 007371 059145	

schwere Qualität



Fleischbeschwerer, Gusseisen / Holz

meat press
presse à grillade
peso per la cottura
prensador para carne
vleespers

Ø cm	Ø inch	Art.-Nr.	EAN	GP
18,0	7	10 6671 10 00	4 007371 060486	

schwere Qualität: 1kg



Hamburger-Wender extra groß

hamburger turner
pelle à hamburger
pala per hamburger
espatula para hamburguesas
hamburger turner

Länge cm	inch	Art.-Nr.	EAN
45,0	17¾	10 6672 28 00	4 007371 060981



GP = Produkt in farbigem Geschenkkarton

KE = auf Karte mit Euroloch

Grillen

Edelstahl rostfrei / stainless steel



Grillbürste

barbecue brush
brosse à grille
spazzola barbeque
cepillo barbacoa
grillborstel

Länge cm	inch	Art.-Nr.	EAN
33,0	13	10 6932 28 33	4 007371 061063
42,0	16½	10 6932 28 42	4 007371 061070



BBQ-Set »Virginia«, 3-teilig, schwarz

Art.-Nr.	EAN
10 6959 10 03	4 007371 056298

Edelstahl / Kunststoff

Set besteht aus:

Gabel: 39 cm; Grillzange: 40 cm; Wender: 42 cm



BBQ-Set »Virginia«, 3-teilig, rot

Art.-Nr.	EAN
10 6959 14 03	4 007371 056304

Edelstahl / Kunststoff

Set besteht aus:

Gabel: 39 cm; Grillzange: 40 cm; Wender: 42 cm



BBQ-Set »Arizona«, 16-teilig, Edelstahl

Art.-Nr.	EAN
10 6968 28 16	4 007371 059220

Der Koffer aus schwarzem Aluminium enthält: 1 Gabel 42 cm, 1 Wender 43 cm, 1 Zange 40 cm, 1 Grillbürste 43 cm, 6 Spieße 41 cm, 6 Maiskolbenhalter



BBQ-Set »Phoenix«, 8-teilig, Edelstahl

Art.-Nr.	EAN
10 6968 28 08	4 007371 061056

Der Koffer aus schwarzem Aluminium enthält: 1 x Gabel 42 cm, 1 Wender 43 cm, 1 Zange 40 cm, 1 Grillbürste 43 cm, 4 Spieße 41 cm

















PARMA Küchenhelfer

Für ein optimales Gelingen benötigt man clevere Helfer - praktisch in der Handhabung, durchdacht in der Funktion, einfach bei der Reinigung. Und das Kochen macht nochmal so viel Spaß.





- spülmaschinenfest
- Design: Ralph Krämer

	<p>Melonenausstecher</p> <p>melon baller bouleur à melon scavino chucara vaciadora melonenballer</p>	<p>Gesamtlänge cm inch</p> <p>19,0 7½</p>	<p>Art.-Nr.</p> <p>12 1000 28 00</p>	<p>EAN</p>  <p>4 007371 030526</p>
	<p>Pizzaschneider</p> <p>pizza cutter roulette à pizza rotella tagliapizza cortador pizzas pizza snijder</p>	<p>Gesamtlänge cm inch</p> <p>21,0 8</p>	<p>Art.-Nr.</p> <p>12 1001 28 00</p>	<p>EAN</p>  <p>4 007371 030533</p>
	<p>Teigrädchen</p> <p>pastry cutter roulette à pâte rotella tagliapasta rueda cortamasa deegrader</p>	<p>Gesamtlänge cm inch</p> <p>19,5 7½</p>	<p>Art.-Nr.</p> <p>12 1003 28 00</p>	<p>EAN</p>  <p>4 007371 030552</p>
	<p>Austernbrecher</p> <p>oyster knife couteau à huitres coltello ostriche rompeostras oestermes</p>	<p>Gesamtlänge cm inch</p> <p>21,0 8</p>	<p>Art.-Nr.</p> <p>12 1004 28 00</p>	<p>EAN</p>  <p>4 007371 030564</p>
	<p>Käsemesser</p> <p>cheese knife couteau à fromage coltello formaggio cuchillo queso kaasmes</p>	<p>Gesamtlänge cm inch</p> <p>30,0 12</p>	<p>Art.-Nr.</p> <p>12 1007 28 00</p>	<p>EAN</p>  <p>4 007371 030595</p>
	<p>Palettenmesser</p> <p>palette knife couteau pelle paletta tagliapizza pala-cuchillo paletmes</p>	<p>Gesamtlänge cm inch</p> <p>29,5 11½</p>	<p>Art.-Nr.</p> <p>12 1008 28 00</p>	<p>EAN</p>  <p>4 007371 030601</p>
	<p>Zitronenzester</p> <p>lemon zester zesteur rigalimoni rallador limón citroenschiltrekker</p>	<p>Gesamtlänge cm inch</p> <p>18,0 7</p>	<p>Art.-Nr.</p> <p>12 1009 28 00</p>	<p>EAN</p>  <p>4 007371 030618</p>
	<p>Muskat- und Zitronenreibe</p> <p>nutmeg grater râpe à muscade grattugia noce moscata rallador nuez moscada nootmuskaatrasp</p>	<p>Gesamtlänge cm inch</p> <p>26,5 10½</p>	<p>Art.-Nr.</p> <p>12 1010 28 00</p>	<p>EAN</p>  <p>4 007371 030625</p>





■ spülmaschinenfest
■ Design: Ralph Krämer

	Käsehobel	Gesamtlänge cm	inch	Art.-Nr.	EAN
	cheese plane rabot à fromage taglia formaggio cortador queso kaasschaaf	26,0	10	12 1011 28 00	4 007371 030632
	Apfelausstecher	Gesamtlänge cm	inch	Art.-Nr.	EAN
	apple corer épépineur foramele descorazonador manzana appelboor	24,0	9½	12 1012 28 00	4 007371 030649
	Palette, gelocht	Gesamtlänge cm	inch	Art.-Nr.	EAN
	palette with holes pelle à trous paletta forata pala perforada bakspaan	28,5	11	12 1013 28 00	4 007371 030656
	Sparschäler, quer	Gesamtlänge cm	inch	Art.-Nr.	EAN
	movable peeler épiluteur pela verdura pela verduras dunschiller	19,0	7½	12 1014 28 00	4 007371 030663
	Sparschäler, hochkant	Gesamtlänge cm	inch	Art.-Nr.	EAN
	movable peeler épiluteur pela verdura pela verduras dunschiller	22,0	8½	12 1015 28 00	4 007371 030670
	Dosenöffner	Gesamtlänge cm	inch	Art.-Nr.	EAN
	can opener ouvre boîte apriscatole abrelatas blikopener	22,0	8½	12 1017 28 00	4 007371 030960
	Dessertportionierer	Gesamtlänge cm	inch	Art.-Nr.	EAN
	dessert server portionneur à dessert porzioniere per gelato porcionador helado dessert-dienlepel	22,5	9	12 1022 28 00	4 007371 032582
	Nylonwender	Gesamtlänge cm	inch	Art.-Nr.	EAN
	nylon turner pelle nylon paletta nylon pala freir nylon nylonspaan	35,5	14	12 1027 28 00	4 007371 033619

Funktionsteil hitzebeständig bis 210°C



GP = Produkt in farbigem Geschenkkarton



KE = auf Karte mit Euroloch



- spülmaschinenfest
- Design: Ralph Krämer

	<p>Gourmethobel</p> <p>truffle plane râpe à truffe tagliatartufi cortador universale truffelrasp</p>	<p>Gesamtlänge cm 30,0</p>	<p>inch 12</p>	<p>Art.-Nr. 12 1029 28 00</p>	<p>EAN 4 007371 039826</p>
	<p>Schöpflöffel</p> <p>soup ladle louche mestolo cazo sopa soeplepel</p>	<p>Gesamtlänge cm 32,0</p>	<p>inch 12½</p>	<p>Art.-Nr. 12 1500 28 00</p>	<p>EAN 4 007371 031653</p>
	<p>Saucenlöffel</p> <p>sauce ladle cuillère à sauce cucchiaio salse cazo salsas sauslepel</p>	<p>Gesamtlänge cm 30,0</p>	<p>inch 12</p>	<p>Art.-Nr. 12 1501 28 00</p>	<p>EAN 4 007371 031660</p>
	<p>Kartoffelstampfer</p> <p>potato masher presse purée schiacciapatate prensa patatas aardappelstamper</p>	<p>Gesamtlänge cm 30,5</p>	<p>inch 12</p>	<p>Art.-Nr. 12 1502 28 00</p>	<p>EAN 4 007371 031677</p>
	<p>Schaumlöffel</p> <p>skimmer écumoire schiumarola espumadera schuimspaan</p>	<p>Gesamtlänge cm 36,0</p>	<p>inch 14</p>	<p>Art.-Nr. 12 1503 28 00</p>	<p>EAN 4 007371 031684</p>
	<p>Fleischgabel</p> <p>meat fork fourchette à viande forchettone tenedor carne vleesfork</p>	<p>Gesamtlänge cm 35,0</p>	<p>inch 13½</p>	<p>Art.-Nr. 12 1504 28 00</p>	<p>EAN 4 007371 031691</p>
	<p>Servierlöffel</p> <p>serving spoon cuillère à servir cucchiaione cucharón servir serveerlepel</p>	<p>Gesamtlänge cm 33,5</p>	<p>inch 13</p>	<p>Art.-Nr. 12 1505 28 00</p>	<p>EAN 4 007371 031707</p>
	<p>Wender</p> <p>turner pelle pala pala freir bakspaan</p>	<p>Gesamtlänge cm 34,5</p>	<p>inch 13½</p>	<p>Art.-Nr. 12 1506 28 00</p>	<p>EAN 4 007371 031714</p>







■ spülmaschinenfest
■ Design: Ralph Krämer

	Spaghettiheber	Gesamtlänge cm	inch	Art.-Nr.	EAN
	spaghetti server cuillère à spaghetti mestolo spaghetti cucharón spaghetti spaghettilepel	32,5	12½	12 1507 28 00	4 007371 031929

	Schneebeesen	Gesamtlänge cm	inch	Art.-Nr.	EAN
	standard whisk fouet frusta batidor garde	30,0	12	12 1508 28 00	4 007371 032094

	Eierwender, Nylon	Gesamtlänge cm	inch	Art.-Nr.	EAN
	egg lifter pelle à œufs paletta pala freir eierbakspaan	38,0	15	12 1509 28 00	4 007371 035330

Funktionsteil hitzebeständig bis 210°C

	Käseschneider	Gesamtlänge cm	inch	Art.-Nr.	EAN
	cheese cutter coupe-fromage taglia formaggio cuchillo para queso kaassnijder	29,0	11½	12 1515 28 00	4 007371 037617



mit Draht für 2 Schnittstärken, mit Servierspitze

	S-Haken, 6er Set	Gesamtlänge cm	inch	Art.-Nr.	EAN
	S-hook chromeplated 6 pcs. set crochet-S chromé 6 pièces uncino-S cromato 6 pz. ganchos-S cromados 6 pzas. S-haken chrom, set van 6 stuks	5,0	2	10 5100 38 06	4 007371 025638

verchromt

	S-Haken	Gesamtlänge cm	inch	Art.-Nr.	EAN
	S-hook chromeplated crochet-S chromé uncino-S cromato ganchos-S cromados S-haak chrom	5,0	2	10 5100 38 50	4 007371 011426
		6,5	2½	10 5100 38 65	4 007371 018968

verchromt

	Wandkuchenleiste, mit Haken	Gesamtlänge cm	inch	Art.-Nr.	EAN	
	heavy grade utensil rack with hooks barre murale avec crochets appendimestolo con uncini listón de pared con ganchos keukenstang met haken	50,0	19	10 5500 28 05	4 007371 008068	
		60,0	23½	10 5500 28 06	4 007371 008105	

inklusive Dübel und Schrauben

Küchenhelfer

Edelstahl rostfrei / stainless steel

Schneebeesen



standard whisk
fouet
frusta
batidor
garde

Länge cm	inch	Art.-Nr.	EAN
15,0	6	10 3504 28 15	4 007371 030397
20,0	8	10 3504 28 20	4 007371 016865
25,0	10	10 3504 28 25	4 007371 016247
30,0	12	10 3504 28 30	4 007371 016254

Kartoffelstampfer »Promo«



potato masher
presse purée
schiacciapatate
prensa patatas
aardappelstamper

Länge cm	inch	Art.-Nr.	EAN
30,0	12	11 0549 28 00	4 007371 020640

Kartoffelstampfer »Profi«

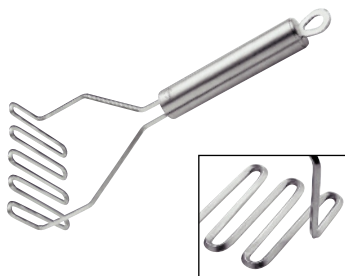

potato masher
presse purée
schiacciapatate
prensa patatas
aardappelstamper

Länge cm	inch	Art.-Nr.	EAN
29,0	11½	11 0600 28 00	4 007371 044073

speziell geformter, eckiger Draht
extra dicker Griff

Magnetleiste

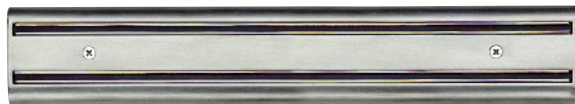

magnetic knife rack
barre magnétique pour couteaux
barra magnetica per coltelli
listón magnético para cuchillos
magnetische messenhouder

L/H cm	inch	Art.-Nr.	EAN
35,5 x 6,0	14 x 2½	10 9100 28 00	4 007371 036269

inklusive Schrauben und Dübel

Spülbürste »Classic«, mit Naturborsten



dish washing brush
brosse pour vaisselle
spazzolino
cepillo cocina
afwasborstel

Gesamtlänge cm	inch	Art.-Nr.	EAN
25,0	10	11 0943 28 00	4 007371 033466

Bürstenkopf austauschbar

Design: Ralph Krämer

Ersatzbürste 2er Set	11 0943 00 02	4 007371 033473
-----------------------------	----------------------	-----------------









Siebe

Edelstahl rostfrei / stainless steel



Profi-Qualität

- extra feines und stabiles Gewebe
- Gewebe mit Rand verschweißt
- Spezial-Verschweißung der Griffe
- große Auflage

	Teesieb tea strainer passe-thé passino tè colador té theezeef	Ø cm 7,5	Ø inch 3	Art.-Nr. 11 0990 28 07	EAN 4 007371 000314
	Küchensieb strainer passoire setaccio colador cocina keukenzeef	Ø cm 9,0	Ø inch 3½	Art.-Nr. 11 0990 28 09	EAN 4 007371 002387
	colador cocina keukenzeef	12,0	5	11 0990 28 12	EAN 4 007371 000321
	keukenzeef	16,0	6½	11 0990 28 16	EAN 4 007371 017275
	Küchensieb strainer passoire setaccio colador cocina keukenzeef	Ø cm 18,0	Ø inch 7	Art.-Nr. 11 0990 28 18	EAN 4 007371 000345
	colador cocina keukenzeef	20,0	8	11 0990 28 20	EAN 4 007371 017282
	keukenzeef	22,0	8½	11 0990 28 22	EAN 4 007371 025058
	Spitzsieb conical sieve chinois conique colino conico colador cócina puntzeef	Ø cm 18,0	Ø inch 7	Art.-Nr. 11 0993 28 18	EAN 4 007371 055505
professionelle Qualität feines, stabiles Gewebe					

Salatschleudern und mehr

Unerlässliche Helfer für die Verarbeitung frischer Zutaten -
Salatschleudern und Dressingshaker, Spätzlepressen und
Käsereiben, Multischneider und Kräutermühlen.

Die Kreativität kommt von Ihnen, die Accessoires von uns.



Praktische Küchenhelfer

Edelstahl rostfrei / stainless steel

Knoblauchschneider

garlic plane
rabot-ail
taglia aglio
corta-ajos
knoflookschaaf



L/B cm	inch	Art.-Nr.	EAN
21,0 x 5,0	8¼ x 2	13 1005 28 00	8 001603 020602

Knoblauchschäler

garlic peeler
éplucher d'ail
sbuccia aglio
pelador de ajo
knoflookschiller



Länge cm	inch	Art.-Nr.	EAN
13,0	5	13 1600 12 00	4 007371 041256

24 Stück im attraktiven Verkaufs-Display

Knoblauchpresse »Quick«, beschichtet

garlic press
éplucheur d'ail
spremiaglio
prensa ajos
knoflookpers



Länge cm	inch	Art.-Nr.	EAN
20,0	8	13 7010 30 00	4 007371 035651

Aluminium, beschichtet, zum Pressen von ungeschälten Knoblauchzehen geeignet

24 Stück im attraktiven Verkaufs-Display



Knoblauchpresse/ -schneider

garlic press/cutter
presse/coupe ail
spremi/taglia aglio
prensa/cortador ajos
knoflookpers/snijder



Länge cm	inch	Art.-Nr.	EAN
19,5	7¾	13 7012 70 00	4 007371 054386

zum Pressen und Schneiden

Kompaktseife »deluxe«

stainless steel soap
savon en inox
sapone inox
jabón inox
edelstaal keukenzeep



Ø cm	Ø inch	Art.-Nr.	EAN
8,0	3	13 1025 28 00	4 007371 034067

24 Stück im attraktiven Verkaufs-Display

Kartoffel- /Spätzlepressen, Pommes-Frites-Schneider

Edelstahl rostfrei / stainless steel

Kartoffelpresse

potato press
presse purée
schiacciapatate
prensa-patatas
pureepers



Ø cm	Länge cm	Ø inch	Art.-Nr.	EAN	GP
8,0	27,0	10½	13 1008 28 00	4 007371 030762	

Kartoffel-/Spätzlepresse

potato / spaetzle press
presse purée / spaetzle
schiacciapatate / -gnocchetti
prensa patatas /pasta fresca
puree- /spätzlepers



Ø cm	Länge cm	Ø inch	Art.-Nr.	EAN	GP
8,0	37,0	3	13 1056 28 00	4 007371 041409	

Kartoffelpresse »Comfort«

potato press
presse purée
schiacciapatate
prensa-patatas
pureepers



L/B cm	inch	Art.-Nr.	EAN	GP
31,5 x 12,5	12½ x 5	13 1069 28 00	4 007371 045919	

Kartoffel-/Spätzlepresse »Spätzleboy«

potato / spaetzle press
presse purée / spaetzle
schiacciapatate / -gnocchetti
prensa patatas /pasta fresca
puree- /spätzlepers



Ø cm	Länge cm	Ø inch	Art.-Nr.	EAN	GP
9,0	42,0	3½	13 1075 30 00	4 007371 056359	

Aluminium-Guss
auch für Spaghetti-Eis geeignet

Pommes-Frites-Schneider

potato cutter
coupe pomme de terre
taglia-patatine
cortador patatas
patat snijder



L/B/H cm	inch	Art.-Nr.	EAN	GP
26,0 x 9,0 x 12,5	10 x 3½ x 5	13 1057 28 00	4 007371 041867	

mit 2 Schneide-Einsätzen (32er und 64er)

Schneiden / Zerkleinern

hochwertige Kunststoffe / high quality plastics

Praktische Küchenhelfer



Multischneider, patentierte Antriebstechnik

multi chopper
multi hachoir
tritattutto
tritadora
multi verkleiner



Ø cm	Höhe cm	Inhalt ltr.	Ø inch	Art.-Nr.	EAN	
13,5	12,0	0,75	5½	13 0750 22 00	4 007371 060479	

Antriebsdeckel, Schleudereinsatz, Schneideinsatz, Aufweiser und Schutzhülle, Mixeinsatz, 0,75L Behälter mit Mikrowellendeckel

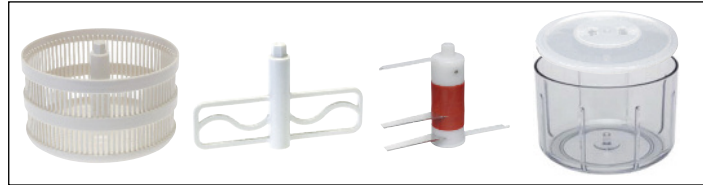

Tomatenschneider

tomato slicer
trancheur à tomate
tagliapomodori
cortador de tomates
tomatensnijder



L/B cm	inch	Art.-Nr.	EAN	
21,5 x 11	8½	13 0709 22 00	4 007371 060639	

extra scharfe, gezahnte Klingen
auch geeignet für Champignons oder Mozzarella

Petersilien-/ Kräutermühle

parsley / herbs mill
moulin à fines herbes
macinino per erbe
molinillo de hierbas
peterseliemolen



Ø / H cm	Ø inch	Art.-Nr.	EAN	
7,0 / 13,0	3	13 0711 22 00	4 007371 060882	



Ananasschneider

pineapple slicer
découpe ananas
taglia ananas
cortador de piña
ananassnijder



Länge cm	inch	Art.-Nr.	EAN	
24,0	9½	13 1091 28 00	4 007371 059152	

Edelstahl rostfrei

Salatschleudern

hochwertige Kunststoffe / high quality plastics

bestehend aus:
Abtropfsieb, Schüssel und
Deckel mit Seilzugtechnik

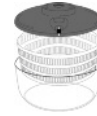

Salatschleuder, schwarz

salad spinner
essoreuse à salade
centrifuga per insalata
centrifugadora de ensalada
slacentrifuge

Ø cm	Höhe cm	Inhalt ltr.	Ø inch	Art.-Nr.	EAN
24,0	16,0	3,25	9½	13 1017 10 00	4 007371 047197

für perfektes Trocknen

Design: Ralph Krämer



Salatschleuder, grün

salad spinner
essoreuse à salade
centrifuga per insalata
centrifugadora de ensalada
slacentrifuge

Ø cm	Höhe cm	Inhalt ltr.	Ø inch	Art.-Nr.	EAN
24,0	16,0	3,25	9½	13 1017 11 00	4 007371 055932

für perfektes Trocknen

Design: Ralph Krämer



Salatschleuder, rot

salad spinner
essoreuse à salade
centrifuga per insalata
centrifugadora de ensalada
slacentrifuge

Ø cm	Höhe cm	Inhalt ltr.	Ø inch	Art.-Nr.	EAN
24,0	16,0	3,25	9½	13 1017 14 00	4 007371 047203

für perfektes Trocknen

Design: Ralph Krämer



Salatschleuder, weiß

salad spinner
essoreuse à salade
centrifuga per insalata
centrifugadora de ensalada
slacentrifuge

Ø cm	Höhe cm	Inhalt ltr.	Ø inch	Art.-Nr.	EAN
24,0	16,0	3,25	9½	13 1017 22 00	4 007371 030458

für perfektes Trocknen

Design: Ralph Krämer



Salatschleuder »Mini«, weiß

salad spinner
essoreuse à salade
centrifuga per insalata
centrifugadora de ensalada
slacentrifuge

Ø cm	Höhe cm	Inhalt ltr.	Ø inch	Art.-Nr.	EAN
20,0	19,5	2,5	8	13 1018 22 00	4 007371 057837

Kurbelfunktion

praktische Öffnung zum Einfüllen oder Abgießen



= Produkt in farbigem Geschenkkarton



= auf Karte mit Euroloch

Salatschleudern / Küchenhelfer

hochwertige Kunststoffe, Edelstahl / high quality plastics, stainless steel



Salatschleuder »Maxi«, weiß

salad spinner
essoreuse à salade
centrifuga per insalata
centrifugadora de ensalada
slacentrifuge

Ø cm	Höhe cm	Inhalt ltr.	Ø inch	Art.-Nr.	EAN	
27,0	17,0	5,0	10½	13 7007 22 00	4 007371 031356	

Deckel mit Seilzugtechnik für perfektes Trocknen



Salatschleuder, Edelstahl

salad spinner
essoreuse à salade
centrifuga per insalata
centrifugadora de ensalada
slacentrifuge

Ø cm	Höhe cm	Inhalt ltr.	Ø inch	Art.-Nr.	EAN	
24,0	17,0	3,25	9½	13 7008 28 00	4 007371 031561	

Deckel mit Seilzugtechnik für perfektes Trocknen
inklusive Basisplatte

Design: Ralph Krämer

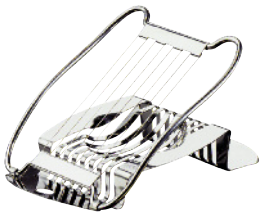

Eierschneider

egg slicer
coupe-œuf
tagliauovo
cortahuevos
eiersnijder

L/B cm	inch	Art.-Nr.	EAN	
15,5 x 9,5	6 x 3¾	13 1026 28 00	4 007371 034463	



Eipicker

egg pricker
perçoir à œuf
forauovo
punzón huevos
eierprikker

Ø cm	Höhe cm	Ø inch	Art.-Nr.	EAN	
4,0	4,0	1½	13 1027 28 00	4 007371 034470	

24 Stück im attraktiven Verkaufs-Display



Eierköpfer »Smart«

egg shell topper
ciseau à œuf
apriuova
abre huevos
ei-onthoofder

L/B cm	inch	Art.-Nr.	EAN	
12,0 x 8,5	5 x 3¾	13 1029 28 00	4 007371 057455	



Ei-Trenner mit Clip

egg separator incl. fixing clip
séparateur à œuf
separa tuorlo
separador de claras de huevo
eierscheider

Ø cm	Ø inch	Art.-Nr.	EAN	
8,0	3	13 1086 28 00	4 007371 052955	

Praktische Küchenhelfer

hochwertige Kunststoffe, Edelstahl / high quality plastics, stainless steel



Schneeschläger

egg beater
bateur à neige
frusta
batidor
slagroomklopper

Länge cm	inch	Art.-Nr.	EAN
31,0	12¼	13 1007 28 00	4 007371 052412



Käsereiber

cheese grater
râpe à fromage
grattugia per formaggio
rallador queso
kaasrasp

Länge cm	inch	Art.-Nr.	EAN
20,0	7¾	13 1021 28 00	4 007371 032261



Glaskeramik-Reiniger

ceramic hob cleaner
spatule pour vitro-céramique
raschiello pulitura piastre vetroceramica
espátula con cuchilla
kookplaatkrabber

L/B cm	inch	Art.-Nr.	EAN
14,5 x 6,0	5¾ x 2½	13 1023 22 00	4 007371 032803

im Display, 24 Stück
mit 2 Ersatzklingen

Design: Ralph Krämer

Ersatzklingen 10 Stück	13 1023 28 10	4 007371 035743
-------------------------------	----------------------	-----------------



Glaskeramik-Reiniger

ceramic hob cleaner
spatule pour vitro-céramique
raschiello pulitura piastre vetroceramica
espátula con cuchilla
kookplaatkrabber

L/B cm	inch	Art.-Nr.	EAN
16,0 x 5,5	6½ x 2	13 1023 00 00	4 007371 056670

12 Stück im attraktiven Verkaufs-Display



Ersatzklingen 10 Stück	13 1023 28 10	4 007371 035743
-------------------------------	----------------------	-----------------



Dressingshaker

dressing shaker
dressing shaker
dressing shaker
agitador salsa
dressingshaker

Ø cm	Höhe cm	Inhalt ltr.	inch	Art.-Nr.	EAN
6,0	20,0	0,25	2½	13 1028 28 00	4 007371 034494

mit Rezepten, Deckel aus Edelstahl



Verschlussklammern, 2er Set

closing clip for food bags
crochet de fermeture pour sachets
alimentaires
mollettone salvafreschezza
pinza para cerrar bolsas
vershoudklem

L/H cm	inch	Art.-Nr.	EAN
7,8 x 6,0	3 x 2½	13 1044 28 00	4 007371 038027



 GP = Produkt in farbigem Geschenkkarton

 KE = auf Karte mit Euroloch

Praktische Küchenhelfer

hochwertige Kunststoffe, Edelstahl / high quality plastics, stainless steel



Bratenzange/ Schneidehilfe

roast tongs / holder
pince / fixe à rôtir
pinza / fissatore per arrosti
pinza corta carne
braadtang / -houder

L/B cm	inch	Art.-Nr.	EAN
29,0 x 7,0	11½ x 2¾	13 1048 28 00	4 007371 039796



Kühlschrank- Geruchskiller

refrigerator odor absorber
absorbeur d'odeurs pour frigo
assorbiodori per frigo
eliminator de malos olores
koelkastluchtjes-verwijderaar

Ø cm	Höhe cm	Ø inch	Art.-Nr.	EAN
6,0	6,0	2½	13 1060 28 00	4 007371 043311



inklusive Kohlefilter;
24 Stück im attraktiven Verkaufs-Display

Kohlefilter einzeln	Art.-Nr.	EAN
	13 1060 00 01	4 007371 043328



Zitronenpresse, klein

lemon/orange squeezer
presse-agrume
spremiagrumi
prensalmiones
citruspers

Ø cm	Höhe cm	Ø inch	Art.-Nr.	EAN
9,0	7,0	3½	13 1032 28 00	4 007371 034647



Zitronenpresse

lemon/orange squeezer
presse-agrume
spremiagrumi
prensalmiones
citruspers

Ø cm	Höhe cm	Ø inch	Art.-Nr.	EAN
13,0	9,0	5	13 6600 28 00	4 007371 022927



Universalöffner »Viper«

jar and bottle opener
ouvre bocal universel
apritutto universale
abridor universal
multi flessenopener

L/B/H cm	inch	Art.-Nr.	EAN
16,0 x 9,5 x 1,5	6½ x 3¾ x ½	13 1071 28 00	4 007371 047234



Sicherheits-Dosenöffner »Easy«

safety can opener
ouvre boîte
apriscatole
abrelatas
blikopener

L/B cm	inch	Art.-Nr.	EAN
18,0 x 5,0	7 x 2	13 1080 10 00	4 007371 052436



Dosenöffner

can opener
ouvre boîte
apriscatole
abrelatas
blikopener

Länge cm	inch	Art.-Nr.	EAN
15,0	6	13 1082 00 00	4 007371 059275

12 Stück im attraktiven Verkaufs-Display
farblich sortiert, schwarz, grün, rot
und orange mit Schutzkappe



Raclette, Fondue und Zubehör

Mit Freunden und Familie schmeckt's nochmal so gut.

In gemütlicher Atmosphäre bereitet jeder köstliche Zutaten ganz individuell nach seinem Geschmack zu. Ob Raclette oder Fondue – Ihrer Kreativität und Phantasie sind keine Grenzen gesetzt.



Kochen am Tisch – 8er Raclettes

Raclette und Zubehör



Raclette »Hot Stone«
mit Steinplatte
Raclette

mit 8 Pfännchen
und 8 Schabern

Art.-Nr. EAN
17 4000 00 00 4 007371 041744

L/B/H cm inch
47,0 x 24,5 x 13,5 18½ x 9½ x 5½

Technische Daten
Betriebsspannung: 230V /~50/60Hz
Leistungsaufnahme: 1200 Watt
Pfännchen separat erhältlich **17 4600 00 00**



Raclette »Grande«
mit Grillplatte
Raclette

mit 8 Pfännchen
und 8 Schabern

Art.-Nr. EAN
17 5500 00 00 4 007371 044721

L/B/H cm inch
47,0 x 24,5 x 13,5 18½ x 9½ x 5½

Technische Daten
Betriebsspannung: 230V /~50/60Hz
Leistungsaufnahme: 1200 Watt
Pfännchen separat erhältlich **17 4600 00 00**



Raclette »Exclusive«
mit Steinplatte und Grillplatte,
Unterteil Edelstahl
Raclette

mit 8 Pfännchen
und 8 Schabern



Art.-Nr. EAN
17 7000 00 00 4 007371 046633

L/B/H cm inch
47,0 x 24,5 x 13,5 18½ x 9½ x 5½

Technische Daten
Betriebsspannung: 230V /~50/60Hz
Leistungsaufnahme: 1200 Watt
Pfännchen separat erhältlich **17 4600 00 00**



Raclette »Style«
Raclette

mit 8 Pfännchen
und 8 Schabern

Art.-Nr. EAN
17 8200 10 00 4 007371 057158

L/B/H cm inch
53,5 x 20,0 x 11,5 21 x 8 x 4½

Technische Daten
Betriebsspannung: 220-240V /~50Hz
Leistungsaufnahme: 1200 Watt
Pfännchen separat erhältlich **17 4600 00 00**



**Raclette-Brettchen,
4er Set**
raclette saucer
planchette à raclette
tabililla raclette
liston para raclette
raclette plankje

L/B cm inch Art.-Nr. EAN
14,0 x 9,5 5½ x 3¾ **17 4800 10 00** 4 007371 047449

Kochen am Tisch – 2er und 4er Raclettes

Raclette »Hot Stone Duo«

Raclette

mit 2 Pfännchen

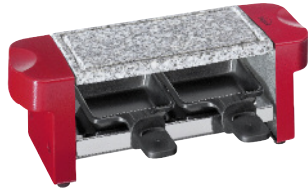

Art.-Nr.	EAN
● 17 8000 00 00	4 007371 049665
● 17 8000 14 00	4 007371 051156
○ 17 8000 22 00	4 007371 051170

L/B/H cm	inch
30,0 x 10,5 x 10,0	12 x 4 x 4

Technische Daten
 Betriebsspannung: 220V–240V /~50/60Hz
 Leistungsaufnahme: 350 – 400 Watt
 Pfännchen separat erhältlich **17 8000 00 01**



Raclette »Hot Stone Quattro«,

Raclette

mit 4 Pfännchen



Art.-Nr.	EAN
● 17 8100 00 00	4 007371 054027
● 17 8100 14 00	4 007371 054126
○ 17 8100 22 00	4 007371 057820

L/B/H cm	inch
50,0 x 10,5 x 10,0	19½ x 4 x 4

Technische Daten
 Betriebsspannung: 220V /~50/60Hz
 Leistungsaufnahme: 600 Watt
 Pfännchen separat erhältlich **17 8000 00 01**

Raclette-Schaber, 8er Set

raclette spatula
 spatule raclette
 spatola raclette
 rasqueta para raclette
 raclette schraper





L/B/H cm	inch	Art.-Nr.	EAN
13,0 x 4,5	5 x 2	17 4850 10 00	4 007371 047456

= Produkt in farbigem Geschenkkarton



= auf Karte mit Euroloch

Kochen am Tisch – Fondue

	Fondueteller, schwarz	Ø cm	Ø inch	Art.-Nr.	EAN
	fondue plate assiette à fondue piatto per fonduta plato fondue fonduebord	25,0	10	21 1020 10 00	4 007371 049528
		Keramik			

	Fondueteller, weiß	Ø cm	Ø inch	Art.-Nr.	EAN
	fondue plate assiette à fondue piatto per fonduta plato fondue fonduebord	25,0	10	21 1020 22 00	4 007371 049535
		Keramik			

	Caquelon »Appenzell«, schwarz	Ø cm	Ø inch	Art.-Nr.	EAN
	cheese fondue casserole caquelon à fondue casseruola per fonduta cacerola fondue fondue caquelon	24,0	9½	21 2510 10 00	4 007371 046800
		Keramik Inhalt: 1,8 ltr.			

	Sicherheits-Brennpaste	Inhalt	Art.-Nr.	EAN	
	safety fuel paste gel combustible de securite pasta combustibile di sicurezza gel combustible más seguro brandpasta	3 x 80g	21 8000 00 00	4 007371 045155	
		Paste besteht aus Bio-Alkohol			

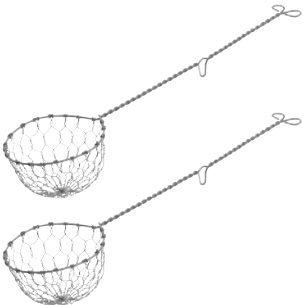
	Siedelöffel, 2 Stück im Set	Länge cm	inch	Art.-Nr.	EAN
	fondue spoon cuillère à fondue cucchiaio fonduta cazo hervidos chinees fondue netje	22,5	9	10 6269 28 02	4 007371 057219

Kochen am Tisch – Fleisch-Fondues

Edelstahl rostfrei / stainless steel



Fondue-Set »St. Moritz«

fondue set
set de fondue
servizio fonduta
set fondue
fondue set

Ø cm	Höhe cm	Ø inch	Art.-Nr.	EAN
19,0	21,0	7½	21 3000 28 00	4 007371 045063

Das Set besteht aus: Fondue-Topf mit Spritzschutz, Rechaud, Sicherheits-Pastenbrenner, 6 Fleischfonduegabeln
Inhalt: 1,9 ltr.

Fondue-Topf geeignet für **Induktion**



Fondue-Set »Lugano«

fondue set
set de fondue
servizio fonduta
set fondue
fondue set

Ø cm	Höhe cm	Ø inch	Art.-Nr.	EAN
20,0	17,0	8	21 3200 28 00	4 007371 045087

Das Set besteht aus: Fondue-Topf mit Spritzschutz, Rechaud, Sicherheits-Pastenbrenner, 6 Fleischfonduegabeln
Inhalt: 1,6 ltr.

Fondue-Topf geeignet für **Induktion**



Fondue-Set »Luzern«

fondue set
set de fondue
servizio fonduta
set fondue
fondue set

Ø cm	Höhe cm	Ø inch	Art.-Nr.	EAN
17,0	21,5	7	21 3300 28 00	4 007371 045094

Das Set besteht aus: Fondue-Topf mit Spritzschutz, Rechaud, Sicherheits-Pastenbrenner, 6 Fleischfonduegabeln
Inhalt: 1,6 ltr.

Fondue-Topf geeignet für **Induktion**



Fondue-Set »Zürich«

fondue set
set de fondue
servizio fonduta
set fondue
fondue set

Ø cm	Höhe cm	Ø inch	Art.-Nr.	EAN
19,5	19,5	7½	21 3400 28 00	4 007371 045100

Das Set besteht aus: Fondue-Topf mit Spritzschutz, Rechaud, Sicherheits-Pastenbrenner, 6 Fleischfonduegabeln
Inhalt: 2,0 ltr.

Fondue-Topf geeignet für **Induktion**

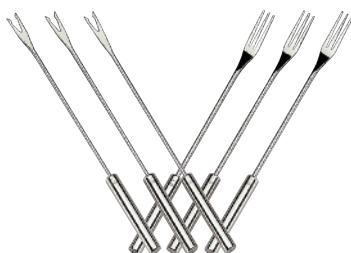

Fonduegabeln »Beef« und »Cheese«, 6er Set

fondue forks
fourchettes à fondue
forchetta per fonduta inox
tenedores fondue
fonduevorkjes edelstaal

	Länge cm	inch	Art.-Nr.	EAN
Fleisch/meat	26,0	10	21 4000 28 06	4 007371 045285
Käse/cheese	26,0	10	21 4100 28 06	4 007371 045292

Kochen am Tisch – Zubehör



Tellerwärmer

Tellerwärmer



Tellerwärmer »XL«

plate warmer
chauffe-assiettes
scaldapiatti
calentador de platos
bordenwarmer

L/B cm	inch	Art.-Nr.	EAN	
200,0 x 30,0	78½ x 12	17 0160 12 00	4 007371 050609	

Technische Daten

Betriebsspannung: 220V–240V /~50/60Hz

Leistungsaufnahme: 200 Watt

für bis zu 12 Menüteller max. 32cm

Crème Brûlée

Eine typische Crème Brûlée mit einer knusprig karamellisierten Zuckerschicht wird für Sie zum Kinderspiel. Die passenden Förmchen für ein stilvolles Servieren finden Sie in unseren attraktiven Geschenksets. Mit dem Gasbrenner, der mit handelsüblichem Butangas gefüllt werden kann, können Sie den Zucker punktgenau nach Ihrem persönlichen Geschmack schmelzen lassen. Ganz so wie bei den Profi-Köchen. Ihre Gäste werden beeindruckt sein.



Crème Brûlée



Crème Brûlée Gas-Brenner »Classic«

gas torch
brûleur de gaz
becco del gas
mechero de gas
gasbrander

Höhe cm	inch	Art.-Nr.	EAN
15,5	6	19 1000 10 00	4 007371 038607

regelbare Leistung:
233 W



Crème Brûlée Gas-Brenner »Chef«

gas torch
brûleur de gaz
becco del gas
mechero de gas
gasbrander

Höhe cm	inch	Art.-Nr.	EAN
15,5	6	19 1900 10 00	4 007371 057363

regelbare Leistung:
321 W



Crème Brûlée Gas-Brenner »Profi«

gas torch
brûleur de gaz
becco del gas
mechero de gas
gasbrander

Höhe cm	inch	Art.-Nr.	EAN
18,0	7	19 2000 38 00	4 007371 038614

regelbare Leistung:
412 W



Crème Brûlée Set, 7-teilig

Crème brûlée set

Höhe Brenner cm	inch	Art.-Nr.	EAN
15,5	6	19 2500 28 07	4 007371 043304

bestehend aus einem Crème Brûlée Brenner (233 W) und
6 ovalen Porzellan-Schälchen



Crème Brûlée Set »Eco«, schwarz, 5-teilig

Crème brûlée set

Höhe Brenner cm	inch	Art.-Nr.	EAN
15,5	6	19 2800 10 05	4 007371 050524

bestehend aus einem Crème Brûlée Brenner (233 W) und
4 ovalen Porzellan-Schälchen



Crème Brûlée Schälchen oval, 6er Set

Crème Brûlée dish
moule à Crème Brûlée
scodella Crème Brûlée
bol para crema catalana
Crème Brûlée schaalte

L/B/H cm	inch	Art.-Nr.	EAN
13,0 x 8,0 x 2,5	5 x 3 x 1	19 2500 00 06	4 007371 043816

hitzebeständig bis 280°C

Edelstahl-Töpfe und Sonstiges

Das Kochgeschirr von Küchenprofi zeichnet sich durch den verkapselten Mehrschicht-Boden aus, der für alle Herdarten, sogar für Induktion geeignet ist. Bewährte Materialien wie rostfreier Edelstahl und hitzebeständiges Glas garantieren ein langlebiges Kochvergnügen.



Edelstahl-Kochgeschirr

mit extra starkem Mehrschichtboden

für alle Herdarten geeignet:

■ Glaskeramik ■ Induktion ■ Halogen ■ Elektro ■ Gas



Topf-Set »Siena«, 4-teilig

pot set, 4 pcs.
ensemble de cocottes, 4 pcs.
batteria di pentole, da 4 pezzi
batería de cocina, 4 piezas
pannenset, 4 delig

	Art.-Nr.	EAN	
geeignet für Induktion	23 8000 28 04	4 007371 043700	

Set besteht aus:
Fleischtopf Ø 16,0 cm, mit Glasdeckel, Inhalt: 1,25 ltr.
Fleischtopf Ø 20,0 cm, mit Glasdeckel, Inhalt: 2,5 ltr.
Bratentopf Ø 20,0 cm, mit Glasdeckel, Inhalt: 3,0 ltr.
Fleischtopf Ø 24,0 cm, mit Glasdeckel, Inhalt: 5,5 ltr.



Pastatopf, mit Einsatz

pasta pot
marmite à pâtes
pasta pentola
olla para pasta
pasta pan

Ø cm	H cm	Inhalt ltr.	Ø inch	Art.-Nr.	EAN	
24,0	18,5	7,5	9½	23 8050 28 24	4 007371 053266	

mit verkapseltem Mehrschichtboden, Edelstahlinsatz und Glasdeckel
geeignet für **Induktion**



Aromabräter mit Glasdeckel

roasting pan with seasoning lid
rôtissoire avec couvercle d'arôme
brasiera con coperchio di aroma
bandeja para rustidos con tapa para sazonar
braadslede met glasdeksel

L/B/H cm	Inhalt ltr.	inch	Art.-Nr.	EAN	
36 x 24 x 10	6,0	14 x 9½ x 4	23 8600 28 36	4 007371 050722	

mit Gittereinsatz
geeignet für Elektro, Gas, Glaskeramik, **Induktion** und Backofen



Multibräter, 3-teilig

roasting pan set, 3 pcs.
universelle rôtissoire
brasiera multiuso
set de bandeja para rustidos
braadslede multifunctioneel

L/B/H cm	Inhalt ltr.	inch	Art.-Nr.	EAN	
36 x 24 x 10	6,0	14 x 9½ x 4	23 8650 28 03	4 007371 050739	

mit Gittereinsatz
geeignet für Elektro, Gas, Glaskeramik, **Induktion** und Backofen



Bayrischer Bräter, mit Sandwichboden

lasagne / roast-pan, sandwich bottom
braisière profi, fond multi-couches
tegame rettangolare, fondo multistrato
placa asar profi, fondo sandwich
ovenschaal, sandwich bodem

L/B/H cm	inch	Art.-Nr.	EAN
32,0 x 20,0 x 6,5	12½ x 8 x 2½	10 7000 28 32	4 007371 035002
35,0 x 25,5 x 6,5	13½ x 10 x 2½	10 7000 28 35	4 007371 035019
40,0 x 26,0 x 6,5	15½ x 10½ x 2½	10 7000 28 40	4 007371 035026

geeignet für Elektro, Gas, Glaskeramik, **Induktion** und Backofen



Deckel zu Bayrischem Bräter

lid for roast-pan
couvercle pour braisière
coperchio per tegame
tapa para placa asar
deksel voor braadslede

L/B/H cm	inch	Art.-Nr.	EAN
35,0 x 25,5 x 6,5	13½ x 10 x 2½	10 7001 28 35	4 007371 038621
40,0 x 26,0 x 6,5	15½ x 10½ x 2½	10 7001 28 40	4 007371 038638



Bayrischer Bräter-Set

lasagne / roast-pan, sandwich bottom
braisière profi, fond multi-couches
tegame rettangolare, fondo multistrato
placa asar profi, fondo sandwich
ovenschaal, sandwich bodem

L/B/H cm	inch	Art.-Nr.	EAN
35,0 x 25,5 x 11,0	13½ x 10 x 4½	10 7010 28 35	4 007371 039253
40,0 x 26,0 x 11,0	15½ x 10½ x 4½	10 7010 28 40	4 007371 039260

geeignet für Elektro, Gas, Glaskeramik, **Induktion** und Backofen

Edelstahl-Kochgeschirr, Schüsseln

mit extra starkem Mehrschichtboden



Butterpfännchen

butter melter
casserole à beurre
pentolino per burro
cazo salsa
boterpannetje

Ø cm	Inhalt ltr.	Ø inch	Art.-Nr.	EAN
10,0	0,25	4	23 7000 28 10	4 007371 051569
12,0	0,5	4½	23 7000 28 12	4 007371 051576

mit Innenskalierung
geeignet für **Induktion**
(abhängig vom Minstdurchmesser der Topferkennung)



Stielkasserolle

saucepan
poêlon
casseruola
cazo
steelpan

Ø cm	Inhalt ltr.	Ø inch	Art.-Nr.	EAN
14,0	0,7	5½	23 7050 28 14	4 007371 051583
16,0	1,0	6½	23 7050 28 16	4 007371 051590

mit Innenskalierung
geeignet für **Induktion**



Wasserbad-Topf, 3-teilig

double boiler
casserole bain marie
casseruola per bagno maria
olla para el baño maria
au-bain-marie pan

Ø cm	Ø inch	Art.-Nr.	EAN
14,0	5½	23 7060 28 14	4 007371 054287

mit Innenskalierung
Inhalt Topf: 1,5 L, Inhalt Einsatz: 1,0 ltr.
Gesamthöhe: 19 cm, Höhe Einsatz: 13 cm
inklusive Glasdeckel; geeignet für **Induktion**



Mini-Töpfchen

mini pot
casserole mini
pentolina
olla pequeña
kookpan klein

Ø cm	Höhe cm	Inhalt ltr.	Ø inch	Art.-Nr.	EAN
12,0	6,5	0,65	4¾	23 7070 28 12	4 007371 053839
14,0	6,5	1,0	5½	23 7070 28 14	4 007371 053846
16,0	7,5	1,5	6¼	23 7070 28 16	4 007371 053853

geeignet für **Induktion**



Rührschüssel, rutschfest

mixing bowl
bol à mixer
ciotola
fuente
kom

Ø cm	Höhe cm	Inhalt ltr.	Ø inch	Art.-Nr.	EAN
16	9,5	1,5	6½	25 0540 28 16	4 007371 060738
20	12,0	2,6	8	25 0540 28 20	4 007371 060745
24	15,0	4,8	9½	25 0540 28 24	4 007371 060752



Schüssel

mixing bowl
bol à mixer
ciotola
fuente
kom

Ø cm	Höhe cm	Inhalt ltr.	Ø inch	Art.-Nr.	EAN
18,0	6,0	1,0	7	25 0550 28 18	4 007371 051187
22,0	8,0	2,0	8½	25 0550 28 22	4 007371 051194
26,0	9,0	3,0	10	25 0550 28 26	4 007371 051200
30,0	10,5	5,5	12	25 0550 28 30	4 007371 051217

 **GP** = Produkt in farbigem Geschenkkarton

 **KE** = auf Karte mit Euroloch

Siebe, Seiher, Schüsseln

Edelstahl rostfrei / stainless steel



Rundschüssel, mit 2 Griffen

mixing bowl with side-handles
bol à mixer rond avec 2 poignées
bastardelle 2 manici
fuente amasar redonda con 2 asas
beslagkom met 2 grepen

Ø cm	Ø inch	Art.-Nr.	EAN
22,0	9	25 0500 28 22	4 007371 028912

Standring zur Rundschüssel

15,0	6	25 0700 10 00	4 007371 028943
------	---	---------------	-----------------



Passiersieb mit Griff

single arm colander
tamis-passoire à poignée
passino
pasador con mango
vergiert met steel

Ø cm	Ø inch	Art.-Nr.	EAN
18,0	7	25 0100 28 18	4 007371 030755



Brühsieb mit Griff

single arm colander
tamis à ébouillanter
colapasta emisférico
colador caldo
vergiert met steel

Ø cm	Ø inch	Art.-Nr.	EAN
20,0	8	25 0200 28 20	4 007371 028820



Gemüseseiher

standing colander
égouttoir sur pieds
colapasta
escurreverduras
vergiert

Ø cm	Ø inch	Art.-Nr.	EAN
24,0	9½	25 0350 28 24	4 007371 047111
26,0	10½	25 0350 28 26	4 007371 048743



Seiher »Innova«, klappbar

colander foldable
passoire en silicone pliante
scolapasta pieghevole
colador plegable
vergiert inklapbaar

	Ø cm	Ø inch	Art.-Nr.	EAN	GP
schwarz	22,0	8½	25 0510 10 22	4 007371 053600	
grün	22,0	8½	25 0510 11 22	4 007371 055536	
rot	22,0	8½	25 0510 14 22	4 007371 053624	



	Ø cm	Ø inch	Art.-Nr.	EAN	GP
schwarz	25,0	10	25 0510 10 25	4 007371 053617	
grün	25,0	10	25 0510 11 25	4 007371 055543	
rot	25,0	10	25 0510 14 25	4 007371 053631	



Scheren und Schneidebretter

Scharfe Klingen und ergonomische Griffe sorgen für komfortables Schneiden. Die innovativen Kräuterscheren mit mehreren hintereinander liegenden Klingen erleichtern das Zerkleinern von frischen Kräutern.

Qualitativ hochwertige Kunststoff-Schneidebretter dürfen in keiner Küche fehlen. Sie sind hygienisch, geschmacks- und geruchsneutral, messerschonend und unzerbrechlich.



Scheren

Edelstahl rostfrei / stainless steel

Scheren

Haushaltsschere XS »Titanium«

kitchen scissors
ciseaux de cuisine
forbice di cucina
tijeras cocina
keukenschaar



Länge cm	inch	Art.-Nr.	EAN	
14,0	5½	23 9920 28 00	4 007371 051729	

Titan-Beschichtung, mit Soft Grip Einlage

Haushaltsschere M »Titanium«

kitchen scissors
ciseaux de cuisine
forbice di cucina
tijeras cocina
keukenschaar



Länge cm	inch	Art.-Nr.	EAN	
21,0	8½	23 9921 28 00	4 007371 051743	

Titan-Beschichtung, mit Soft Grip Einlage

Haushaltsschere L »Titanium«

kitchen scissors
ciseaux de cuisine
forbice di cucina
tijeras cocina
keukenschaar



Länge cm	inch	Art.-Nr.	EAN	
25,0	10	23 9922 28 00	4 007371 051750	

Titan-Beschichtung, mit Soft Grip Einlage

Kräuterschere »Titanium«

herb scissors
ciseaux à herbes
forbice per erbe
tieras corta-hierbas
kruidenschaar



Länge cm	inch	Art.-Nr.	EAN	
19,0	7½	23 9925 28 00	4 007371 055024	

inklusive Reinigungskamm
mit 5-fach Klinge
Titan-Beschichtung, mit Soft Grip Einlage

Geflügelschere

poultry scissors
cisailles à volaille
trinciapolli
tijeras aves
gevogelte-schaar



Länge cm	inch	Art.-Nr.	EAN	
25,0	10	09 2300 28 00	4 007371 034906	

mit Sicherheitsverschluss

Geflügelschere »Profi«

poultry scissors
cisailles à volaille
trinciapolli
tijeras aves
gevogelte-schaar



Länge cm	inch	Art.-Nr.	EAN	
24,0	9½	09 2350 28 00	4 007371 047685	

mit Sicherheitsverschluss





Scheren

Edelstahl rostfrei / stainless steel



Küchenschere

kitchen scissors
ciseaux de cuisine
forbice di cucina
tijeras cocina
keukenschaar



	Länge cm	inch	Art.-Nr.	EAN	
●	19,0	7½	23 9900 28 00	4 007371 036856	
●	19,0	7½	23 9900 11 00	4 007371 060561	
●	19,0	7½	23 9900 14 00	4 007371 060578	



Küchenschere

kitchen scissors
ciseaux de cuisine
forbice di cucina
tijeras cocina
keukenschaar





	Länge cm	inch	Art.-Nr.	EAN	
	20,0	8	23 9950 28 00	4 007371 042666	

Kräuterschere

herb scissors
ciseaux à herbes
forbice per erbe
tieras corta-hierbas
kruidenschaar





	Länge cm	inch	Art.-Nr.	EAN	
	20,0	8	23 9910 28 00	4 007371 048446	

mit 3-fach Klinge

Kräuterschere

herb scissors
ciseaux à herbes
forbice per erbe
tieras corta-hierbas
kruidenschaar



	Länge cm	inch	Art.-Nr.	EAN	
●	20,0	8	23 9910 11 00	4 007371 061087	
●	20,0	8	23 9910 14 00	4 007371 061094	

mit 3-fach Klinge



Schneidebretter

hochwertiger Kunststoff / high quality plastics

	Frühstücksbrett, weiß breakfast board planche à tartiner tagliere colazione bandeja ontbijt plankje	L/B cm 25,0 x 16,5	inch 10 x 6	Art.-Nr. 23 2516 22 00	EAN 4 007371 039505
	Schneidebrett, weiß cutting board planche à découper tagliere tabla cortar snijplankje	L/B cm 27,0 x 20,0	inch 10½ x 8	Art.-Nr. 23 2720 22 00	EAN 4 007371 039567
	Schneidebrett, weiß, mit Saftrille cutting board planche à découper tagliere tabla cortar snijplankje met sapgeul	L/B cm 36,0 x 26,0	inch 14 x 10	Art.-Nr. 23 3626 22 00	EAN 4 007371 039598
	Frühstücksbrett, granit breakfast board planche à tartiner tagliere colazione bandeja ontbijt plankje	L/B cm 25,0 x 16,5	inch 10 x 6	Art.-Nr. 23 2516 50 00	EAN 4 007371 039512
	Schneidebrett, granit cutting board planche à découper tagliere tabla cortar snijplankje	L/B cm 27,0 x 20,0	inch 10½ x 8	Art.-Nr. 23 2720 50 00	EAN 4 007371 039574
	Schneidebrett, granit, mit Saftrille cutting board planche à découper tagliere tabla cortar snijplankje met sapgeul	L/B cm 36,0 x 26,0	inch 14 x 10	Art.-Nr. 23 3626 50 00	EAN 4 007371 039604



GP = Produkt in farbigem Geschenkkarton



KE = auf Karte mit Euroloch

Schneidebretter

hochwertiger Kunststoff / high quality plastics



Schneidebrett »Colore«, rot

cutting board
planche à découper
tagliere
tabla cortar
snijplankje met sappeul

L/B/H cm	inch	Art.-Nr.	EAN
25,0 x 15,0 x 0,9	10 x 6 x 1/8	23 1000 14 25	4 007371 060769
29,0 x 20,0 x 0,9	11 1/2 x 8 x 1/8	23 1000 14 29	4 007371 060776
36,5 x 25,0 x 1,0	14 1/2 x 10 x 1/8	23 1000 14 36	4 007371 060783
42,0 x 29,0 x 1,0	16 1/2 x 11 1/2 x 1/8	23 1000 14 42	4 007371 060790

Schneidebrett »Colore«, weiß

cutting board
planche à découper
tagliere
tabla cortar
snijplankje met sappeul



L/B/H cm	inch	Art.-Nr.	EAN
25,0 x 15,0 x 0,9	10 x 6 x 1/8	23 1000 22 25	4 007371 060806
29,0 x 20,0 x 0,9	11 1/2 x 8 x 1/8	23 1000 22 29	4 007371 060813
36,5 x 25,0 x 1,0	14 1/2 x 10 x 1/8	23 1000 22 36	4 007371 060820
42,0 x 29,0 x 1,0	16 1/2 x 11 1/2 x 1/8	23 1000 22 42	4 007371 060837



Schneidebrett »Colore«, granit

cutting board
planche à découper
tagliere
tabla cortar
snijplankje met sappeul



L/B/H cm	inch	Art.-Nr.	EAN
25,0 x 15,0 x 0,9	10 x 6 x 1/8	23 1000 50 25	4 007371 060844
29,0 x 20,0 x 0,9	11 1/2 x 8 x 1/8	23 1000 50 29	4 007371 060851
36,5 x 25,0 x 1,0	14 1/2 x 10 x 1/8	23 1000 50 36	4 007371 060868
42,0 x 29,0 x 1,0	16 1/2 x 11 1/2 x 1/8	23 1000 50 42	4 007371 060875



Würzen und mehr

Gewürze – im praktischen Drehständer immer griffbereit zur Hand.

Ganz nebenbei durch attraktiven Material-Mix ein optisches Highlight in jeder Küche.



Gewürzständer



Edelstahl-Gewürzständer, drehbar

revolving spice rack, wood
présentoir épices, bois
portaspezie legno
soporte especias, haya
houten kruiden standaard

Höhe cm	inch	Art.-Nr.	EAN
30,0	12	26 0300 28 16	4 007371 058865

rund,
ungefüllt mit Aufklebern

Holz-Gewürzständer

revolving spice rack, wood, filled
présentoir épices, bois, rempli
portaspezie legno, ripieno
soporte especias, haya, lleno
houten kruiden standaard, gevuld

Höhe cm	inch	Art.-Nr.	EAN
23,0	9	26 0400 10 12	4 007371 058780

rund,
gefüllt mit 12 verschiedenen Gewürzen



Holz-Gewürzständer

revolving spice rack, wood, filled
présentoir épices, bois, rempli
portaspezie legno, ripieno
soporte especias, haya, lleno
houten kruiden standaard, gevuld

Höhe cm	inch	Art.-Nr.	EAN
28,0	11	26 0400 10 16	4 007371 058797

rund,
gefüllt mit 16 verschiedenen Gewürzen



Gewürzständer

Gewürzständer, drehbar

revolving spice rack, wood, filled
présentoir épices, bois, rempli
portaspezie legno, ripieno
soporte especias, haya, lleno
houten kruiden standaard, gevuld



Höhe cm	inch	Art.-Nr.	EAN	
30,0	12	26 0500 28 16	4 007371 041638	

rund, Holz mit Edelstahl kombiniert,
gefüllt mit 16 verschiedenen Gewürzen

Gewürzglas einzeln, leer	26 0050 00 00	4 007371 030731
---------------------------------	---------------	-----------------

Gewürzständer, drehbar

revolving spice rack, wood, filled
présentoir épices, bois, rempli
portaspezie legno, ripieno
soporte especias, haya, lleno
houten kruiden standaard, gevuld



Höhe cm	inch	Art.-Nr.	EAN	
30,0	12	26 0550 28 16	4 007371 048286	

rund, Holz mit Edelstahl kombiniert,
gefüllt mit 16 verschiedenen Gewürzen

Gewürzglas einzeln, leer	26 0050 00 00	4 007371 030731
---------------------------------	---------------	-----------------

Gewürzständer

spice rack, wood, filled
présentoir épices, rempli
portaspezie, ripieno
soporte especias, lleno
houten kruiden standaard, gevuld



L/B/H cm	inch	Art.-Nr.	EAN	
29,5 x 9,0 x 21,5	11½ x 3½ x 8½	26 0750 28 12	4 007371 048736	

Holz mit Edelstahl kombiniert,
zum Stellen oder Aufhängen (inklusive Dübel und Schrauben),
gefüllt mit 12 verschiedenen Gewürzen

Gewürzglas einzeln, leer	26 0050 00 00	4 007371 030731
---------------------------------	---------------	-----------------

Pfeffer- und Salzmühlen



KÜCHENPROFI

- gefüllt mit Pfeffer und Salz
- mit hochwertigem Keramik-Mahlwerk
- 20 Jahre Garantie auf das Mahlwerk



Meersalz

sea salt
sel de mer
sale marino
sal marina
zeezout

Inhalt	Art.-Nr.	EAN
250 g	30 0100 00 00	4 007371 029544



Schwarzer Pfeffer

black pepper
poivre noir
pepe nero
pimienta negra
zwarte peper

Inhalt	Art.-Nr.	EAN
100 g	30 0105 00 00	4 007371 032124



Mini-Streuer, 4er Set

dredger, 4 pcs. set
saupoudreur, 4 pcs.
spargitutto, set 4 pz.
esparcidor, 4 pzs.
strooier, 4 stuks

L/B/H cm	inch	Art.-Nr.	EAN	GP
3,0 x 3,0 x 4,0	1 x 1 x 1½	30 1200 66 00	4 007371 040853	



Midi-Mühlen Set Acryl

pepper mill, salt mill
moulin à poivre, moulin à sel
macinapepe, macinasale
molinillo de pimienta, molinillo de sal
pepermolen, zoutmolen

L/B/H cm	inch	Art.-Nr.	EAN	GP
3,5 x 3,5 x 8,5	1½ x 1½ x 3½	30 4270 66 00	4 007371 044011	



Pfeffer- & Salzmühen-Set Acryl

pepper mill, salt mill
moulin à poivre, moulin à sel
macinapepe, macinasale
molinillo de pimienta, molinillo de sal
pepermolen, zoutmolen

Ø cm	Höhe cm	Ø inch	Art.-Nr.	EAN	GP
4,5	14,0	5½	30 4290 66 00	4 007371 045506	



Pfeffer- & Salzmühle Acryl

pepper mill, salt mill
moulin à poivre, moulin à sel
macinapepe, macinasale
molinillo de pimienta, molinillo de sal
pepermolen, zoutmolen

	Höhe cm	inch	Art.-Nr.	EAN	GP
Pfefermühle	14,5	6	30 2006 66 00	4 007371 032889	
Salzmühle	14,5	6	30 2007 66 00	4 007371 032896	

GP = Produkt in farbigem Geschenkkarton

KE = auf Karte mit Euroloch

Würzen und mehr

Pfeffer- und Salzmühlen

- gefüllt mit Pfeffer und Salz
- mit hochwertigem Keramik-Mahlwerk
- 20 Jahre Garantie auf das Mahlwerk

Pfeffer- & Salzmühle, Acryl

pepper mill, salt mill
moulin à poivre, moulin à sel
macinapepe, macinasale
molinillo de pimienta, molinillo de sal
pepermolen, zoutmolen



	Höhe cm	inch	Art.-Nr.	EAN
Pfeffermühle	10,5	4	30 8003 66 00	4 007371 046213
Salzmühle	10,5	4	30 8004 66 00	4 007371 046220

»Family Mini«

Pfeffer- & Salzmühle, Acryl

pepper mill, salt mill
moulin à poivre, moulin à sel
macinapepe, macinasale
molinillo de pimienta, molinillo de sal
pepermolen, zoutmolen



	Höhe cm	inch	Art.-Nr.	EAN
Pfeffermühle	14,0	5½	30 8000 66 00	4 007371 035224
Salzmühle	14,0	5½	30 8001 66 00	4 007371 035231

»Family Maxi«

Pfeffer- & Salzmühle Acryl/Chrom

pepper mill, salt mill
moulin à poivre, moulin à sel
macinapepe, macinasale
molinillo de pimienta, molinillo de sal
pepermolen, zoutmolen



	Höhe cm	inch	Art.-Nr.	EAN	
Set	13,0	5	30 4415 38 00	4 007371 046589	

»New York«

Pfeffer- & Salzmühle Acryl/Chrom

pepper mill, salt mill
moulin à poivre, moulin à sel
macinapepe, macinasale
molinillo de pimienta, molinillo de sal
pepermolen, zoutmolen



	Höhe cm	inch	Art.-Nr.	EAN	
Pfeffermühle	18,0	7	30 4416 38 00	4 007371 046596	
Salzmühle	18,0	7	30 4417 38 00	4 007371 046602	
Set	18,0	7	30 4418 38 00	4 007371 048255	

»Manhattan«

Pfeffer- & Salzmühlen-Set, Acryl/Chrom

pepper mill, salt mill
moulin à poivre, moulin à sel
macinapepe, macinasale
molinillo de pimienta, molinillo de sal
pepermolen, zoutmolen



	Ø cm	Höhe cm	Ø inch	Art.-Nr.	EAN	
	4,5	14,0	5½	30 4430 38 00	4 007371 050982	

»Montreal«



Pfeffer- und Salzmühlen

- gefüllt mit Pfeffer und Salz
- mit hochwertigem Keramik-Mahlwerk
- 20 Jahre Garantie auf das Mahlwerk



Mini-Mühlen Set Edelstahl/Acryl

pepper mill, salt mill
moulin à poivre, moulin à sel
macinapepe, macinasale
molinillo de pimienta, molinillo de sal
pepermolen, zoutmolen

Ø cm	Höhe cm	Ø inch	Art.-Nr.	EAN
3,0	5,5	2	30 4250 28 00	4 007371 041553

»Sydney«



Mini-Mühlen Set Edelstahl/Acryl

pepper mill, salt mill
moulin à poivre, moulin à sel
macinapepe, macinasale
molinillo de pimienta, molinillo de sal
pepermolen, zoutmolen

Höhe cm	inch	Art.-Nr.	EAN
schwarz 5,5	2	30 4250 10 00	4 007371 060387
weiß 5,5	2	30 4250 22 00	4 007371 060394

»Sydney«



Peffer- und Salzmühle, Edelstahl/Acryl, mit zwei Mahlwerken

pepper and salt mill
moulin à poivre, moulin à sel
macinapepe, macinasale
molinillo de pimienta, molinillo de sal
pepermolen, zoutmolen

Ø cm	Höhe cm	Ø inch	Art.-Nr.	EAN
3,0	10,5	2	30 4251 28 00	4 007371 060424

»Sydney«



Peffer- und Salzmühle, Edelstahl/Acryl, lackiert, mit zwei Mahlwerken

pepper and salt mill
moulin à poivre, moulin à sel
macinapepe, macinasale
molinillo de pimienta, molinillo de sal
pepermolen, zoutmolen

Höhe cm	inch	Art.-Nr.	EAN
schwarz 10,5	2	30 4251 10 00	4 007371 060400
weiß 10,5	2	30 4251 22 00	4 007371 060417

»Sydney«



Midi-Mühlen Set Edelstahl/Acryl

pepper mill, salt mill
moulin à poivre, moulin à sel
macinapepe, macinasale
molinillo de pimienta, molinillo de sal
pepermolen, zoutmolen

Ø cm	Höhe cm	Ø inch	Art.-Nr.	EAN
3,5	8,5	3½	30 4255 28 00	4 007371 045490

»Vienna«



Pfeffer- & Salzmühle Edelstahl/Acryl

pepper mill, salt mill
moulin à poivre, moulin à sel
macinapepe, macinasale
molinillo de pimienta, molinillo de sal
pepermolen, zoutmolen

Höhe cm	inch	Art.-Nr.	EAN
Pfeffermühle 16,0	6½	30 1170 28 00	4 007371 039314
Salzmühle 16,0	6½	30 1171 28 00	4 007371 039321

»Milano«

Pfeffer- und Salzmühlen

- gefüllt mit Pfeffer und Salz
- mit hochwertigem Keramik-Mahlwerk
- 20 Jahre Garantie auf das Mahlwerk



Pfeffer- & Salzmühle Edelstahl/Acryl

pepper mill, salt mill
moulin à poivre, moulin à sel
macinapepe, macinasale
molinillo de pimienta, molinillo de sal
pepermolen, zoutmolen

	Höhe cm	inch	Art.-Nr.	EAN	
Pfeffermühle	16,0	6½	30 8008 66 00	4 007371 060509	
Salzmühle	16,0	6½	30 8009 66 00	4 007371 060677	

»Memphis«

Chilimühle

chili mill
moulin à piment
macinapeperoncino
molinillo de aji
chilimolen



Ø cm	Höhe cm	Ø inch	Art.-Nr.	EAN	
5,0	19,0	2 x 7½	30 8011 28 00	4 007371 060950	

»San Antonio«

Pfeffermühle & Salzstreuer Edelstahl/Acryl

pepper mill/salt shaker
moulin à poivre/salière
macinapepe/spargisale
molinillo de pimienta/salero
pepermolen/zoutstrooier



Ø cm	Höhe cm	Ø inch	Art.-Nr.	EAN	
4,0	12,5	5	30 4300 28 00	4 007371 040921	
4,5	17,5	7	30 4350 28 00	4 007371 040938	

»London«

Pfeffermühle mit integriertem Salzstreuer

Pfeffer- und Salzmühle, Acryl/Chrom, mit zwei Mahlwerken

pepper and salt mill
moulin à poivre et sel
macinapepe & sale
molinillo de pimienta & sal
peper & zoutmolen



Ø cm	Höhe cm	Ø inch	Art.-Nr.	EAN	
9,0	11,5	3½	30 4420 38 00	4 007371 049504	

»Houston«

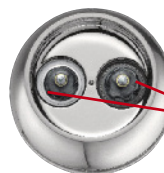

Die Mühle ist mit zwei getrennten, hochwertigen Keramik-Mahlwerken ausgestattet.

Einstellschrauben für feines oder grobes Mahlen.

Pfeffer- und Salzmühle, Edelstahl/Acryl, mit zwei Mahlwerken

pepper and salt mill
moulin à poivre et sel
macinapepe & sale
molinillo de pimienta & sal
peper & zoutmolen



Ø cm	Höhe cm	Ø inch	Art.-Nr.	EAN	
6,0	13,5	2½	30 4440 28 00	4 007371 054515	

»Trattoria«

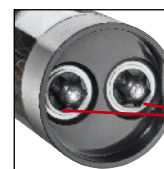

Die Mühle ist mit zwei getrennten, hochwertigen Keramik-Mahlwerken ausgestattet.

Einstellschrauben für feines oder grobes Mahlen.



Praktische Küchenhelfer

Edelstahl rostfrei / stainless steel

Pfeffer- & Salzmühle Edelstahl

pepper mill, salt mill
moulin à poivre, moulin à sel
macinapepe, macinasale
molinillo de pimienta, molinillo de sal
pepermolen, zoutmolen





	Höhe cm	inch	Art.-Nr.	EAN	
Pfeffermühle	11,5	4½	30 4400 28 12	4 007371 041515	
Salzmühle	11,5	4½	30 4401 28 12	4 007371 041522	

»Tavola«

Pfeffer- & Salzmühle Edelstahl

pepper mill, salt mill
moulin à poivre, moulin à sel
macinapepe, macinasale
molinillo de pimienta, molinillo de sal
pepermolen, zoutmolen



	Höhe cm	inch	Art.-Nr.	EAN	
Pfeffermühle	19,0	7½	30 4400 28 19	4 007371 041492	
Salzmühle	19,0	7½	30 4401 28 19	4 007371 041508	

»Tavola«

elektrische Pfeffermühle, Edelstahl/Acryl

electric pepper & salt mill
moulin à poivre & sel électrique
macinapepe & macinasale elettrico
molinillo pimienta & sal eléctrico
peper & zoutmolen elektrisch



	Höhe cm	inch	Art.-Nr.	EAN	
	16,0	6	30 4070 28 00	4 007371 043601	

»Toscana«

mit LED-Licht
inklusive Batterien

elektrisches Pfeffer- & Salzmühlen-Set, Edelstahl/Acryl

electric pepper & salt mill
moulin à poivre & sel électrique
macinapepe & macinasale elettrico
molinillo pimienta & sal eléctrico
peper & zoutmolen elektrisch



	Höhe cm	inch	Art.-Nr.	EAN	
	16,0	6	30 4072 28 00	4 007371 047791	

»Toscana«

mit LED-Licht
inklusive Batterien

Würzen und mehr

Werbemittel

**Sprechen Sie uns auf Ihre optimale Warenpräsentation an!
(Ansprechpartner siehe Seite 141)**



Beispiel einer kompakten Shoplösung, bestehend aus einem Mittelraumaufsteller und zwei Kopfgondeln.

Werbemittel



Beispiel einer kompakten Shoplösung, Markenpräsentation im aktuellen Design

Werbemittel



GP = Produkt in farbigem Geschenkkarton



KE = auf Karte mit Euroloch

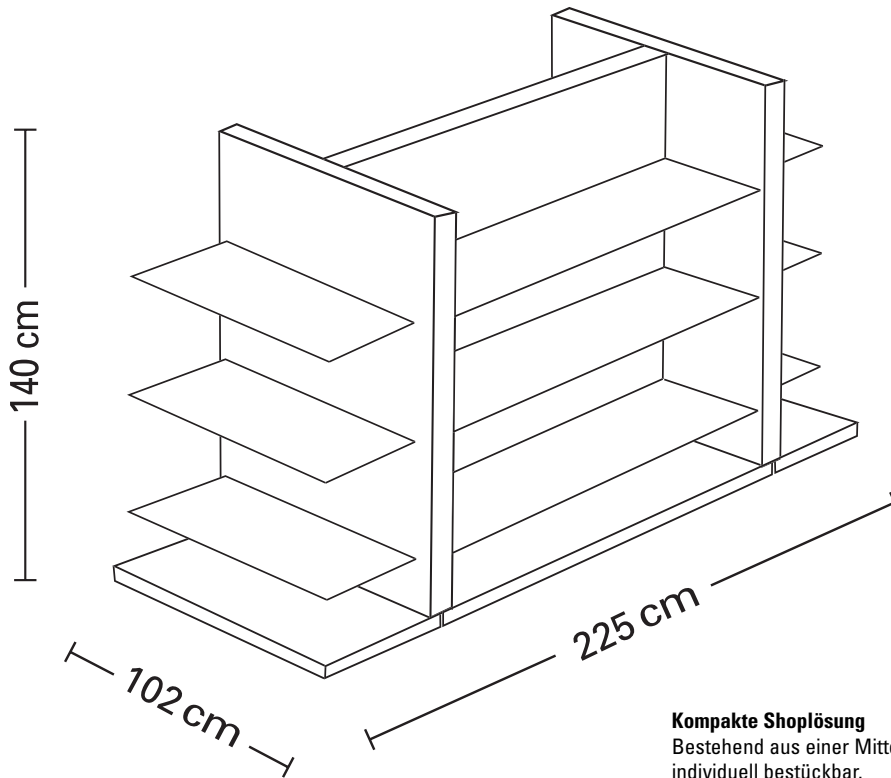

Kompakte Shoplösung

Bestehend aus einer Mittelraumgondel und zwei Kopfgondeln, individuell bestückbar.
Mit drei Logos

Maße gesamt: B: 2250 mm, T: 1020 mm, H: 1400 mm

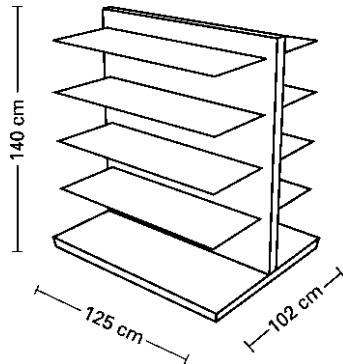

Mittelraumgondel ohne Beleuchtung

Maße: B: 1250 mm, T: 1020 mm, H: 1400 mm
Maße der Glasscheiben: 1170 x 400 mm

Grundelement mit Logo

Bestückung Variante 1: 3 Glasböden + 3 Hakenleisten (je 10 Haken)

Bestückung Variante 2: 6 Glasböden

Wert: 680,00 €

Optional mit Beleuchtung (4 Leuchtstoffröhren à 21 Watt)

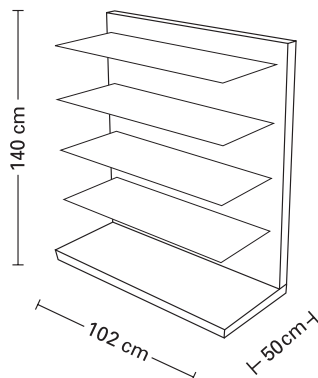

Kopfgondel ohne Beleuchtung

Maße: B: 1020 mm, T: 500 mm, H: 1400 mm
Maße der Glasscheiben: 940 x 400 mm

Grundelement mit Logo

Bestückung Variante 1: 3 Glasböden

Bestückung Variante 2: 3 Hakenleisten mit je 10 Haken

Wert: 480,00 €

Optional mit Beleuchtung (4 Leuchtstoffröhren à 21 Watt)



GP = Produkt in farbigem Geschenkkarton



KE = auf Karte mit Euroloch

Werbemittel

Werbebanner



L/H cm	Art.-Nr.	EAN
40,0 x 112,0 Guss	00 2130 00 00	4 007371 053020
40,0 x 112,0 Porzellan	00 2120 00 00	4 007371 053013
40,0 x 112,0 Pasta	00 2110 00 00	4 007371 053006
40,0 x 112,0 Spargel	00 2140 00 00	4 007371 053037
40,0 x 112,0 Grillen	00 2150 00 00	4 007371 053044

einseitig bedruckt, inklusive Posterschielen und Aufhängeösen

Flyer



L/H cm	Art.-Nr.	EAN
21,0 x 10,0 Provence	00 1905 00 01	4 007371 060448
7,5 x 22,5 Dekorierlöffel	00 1960 00 00	4 007371 059435
10,0 x 21,0 Pizza/Pasta	00 2110 00 02	4 007371 061131
10,0 x 21,0 Tee	00 1970 00 00	4 007371 060998
10,0 x 21,0 Reiben	00 2160 00 01	4 007371 053501

Acrylglasblock



B/H/T cm	inch	Art.-Nr.	EAN
15,0 x 6,5 x 2,0	6 x 2½ x ¾	00 0110 00 00	4 007371 060936

Einkaufstasche Stoff



B/H/T cm	inch	Art.-Nr.	EAN
35,0 x 45,0 x 16,0	13¾ x 17¾ x 6¾	00 1001 00 00	4 007371 031349

Acrylaufsteller



B/H/T cm	inch	Art.-Nr.	EAN
11,0 x 20,0 x 7,5	4¼ x 7¾ x 3	00 0111 00 00	4 007371 030250



sales representatives

Austria

Josef Senn
Schmiedgasse 7
A-6020 Innsbruck
Tel.: +43 512 342 040
Fax: +43 512 342 041
Mobil: +43 664 3 001 176
e-mail: info@agentur-senn.at

Belgium

Jean-Luc Badin
6, rue G. Hautmont
B-7130 Binche
Tel.: +32 64 336 481
Fax: +32 64 336 481
e-mail: jlbadin@skynet.be

France

Pascal Glorieux
Glop Studio
11 rue Fénelon
F-75010 Paris
Tel.: +33 1 42 812 489
Mobil: +33 680 622 863
e-mail: contact@glopstudio.fr

Luxembourg

Christian Schnarrenberger
Weckshof 11
D-42657 Solingen
Tel.: +49 212 2 256 782
Fax: +49 212 22 579 984
e-mail: ch.schnarrenberger@web.de

Netherlands

A.G. Kessler & Zn. v.o.f.
Vermogenweg 209
NL-3641 ST Mijdrecht
Tel.: +31 297 250 561
Fax: +31 297 284 837
e-mail: info@kessler.nl
www.kessler.nl

our partners

Argentina

Representaciones Albis S.A. de C.V.
Av. Hermanos Serdan No. 689-A
col. San Rafael Poniente
C.P. 72029 Puebla, Pue
Tel.: +52 1 228 915 731
Fax: +52 1 8 002 110 406
info@albis.com.mx

Bulgaria

SIA ltd.
Zona B-5; bl. 18, ap. 9
BG-1303 Sofia
Tel.: +359 2 9206 217
Fax: +359 2 920 291
office@siabg.net

Columbia

Ambientes Accesorios S.A.
Calle 66 No. 20-15
Bogota
Tel.: +571 248 1 655
Fax: +571 215 9 930
carmina.villegas@carminavillegas.com

Cyprus

Parousias Ltd.
L Arh.Makariou C & Z Souza
1075 Lefkosia/Nicosia
Tel.: +30 210 9 478 130
Fax: +30 210 9 415 002
dnasi@sarafidisgroup.gr

Czech Republic

Mobax CR s.r.o.
Suchdolska 782
CZ-25358 Horomerice
Tel.: +420 233 920 408
Fax: +420 233 920 411
mobax@mobaz.cz

Finland

Decanter Oy Ltd
Melkonkatu 24
FI -00210 Helsinki
Tel.: +358 505 771 306
Fax: +358 9 68 604 127
decanter@decanter.fi

Great Britain

Gilberts Food Equipment Limited
1 Warwick Place, Warwick Road
Borehamwood, Herts WD6 1UA / GB
Tel.: +44 20 87 313 700
Fax: +44 20 87 313 737
info@gilberts-foodequipment.co.uk

Greece

Cook-Shop Chain
Berson/ C. Sarafidis Bros. S.A.
GR-17675 Kalithea – Athen
Tel.: +30 2310 9928 472
Fax: +30 2310 932 115
cookshop@sarafidisgroup.gr

Israel

Malys H & M Ltd.
3 Hasadna st. Industrial Area
58814 Hulon
Tel.: +972 3 5 502 996
Fax: +972 3 5 501 107
haim@malys.co.il

Italy

Schönhuber SpA
Via J.G. Mahl 52
I-39031 Brunico
Tel.: +39 0474 571 000
Fax: +39 0474 571 099
info@schoenhuber.com

Korea

Peniel Ind. Co., Ltd.
699 Yulseok-ri, Wabu-eup,
Namyangju-City
Tel.: +82 31 5 766 848
Fax: +82 31 5 766 849
philip7@elcuizen.com

Jordan

Irfan Tading Stores
Al-Sveifia, Yacoub Muammar Str. 7
P.O. Box 5560
Amman
Tel.: +962 06 5 811 170
Fax: +962 06 5 821 200
info@irfanjo.com

Mexico

Representaciones Albis, S.A. de C.V.
Blvd. Hermanos Serdán No. 689 A
Col. San Rafael Poniente
C.P. 72029 Puebla, Pue.
Tel.: +52 222 8 915 731
Fax: +52 222 8 915 733
info@albis.com.mx

Norway

Matec Maskiner AS
Welhavensvei 1
N-4319 Sandnes
Tel.: +47 51 526 580
Fax: +47 51 528 498
jone@matec.no
www.matec.no

Peru

Viewcorp S.A.C.
Av.Pardo y Aliaga 699-303B
27 San Isidro, Lima
Tel.: +51 1 4412 567
Fax: +51 1 4214 377
ron@viewcorp-trading.com

Poland

FreeForm
Ul. Kobialka 60
03-044 Warschau
Tel.: +48 225 199 380
Fax: +48 225 199 381
janusz@freeform.com.pl

Portugal

Lobena Lda.
Rua das Pedreiras, 345
Zona Ind. Sao Caetano
Vilar do Paraíso
P-4405-587 Vila Nova de Gaia
Tel.: +351 227 115 821
+351 227 115 579
Fax: +351 227 115 861
lobena@lobena.pt

Russia

MSW Aussenhandel
Annette-Kolb-Weg 1
D-65462 Ginsheim
Tel.: +49 6144 334 131
Fax: +49 6144 334 133
msw.gin@googlemail.com

Slovenia

RUBICO TRADE D.O.O.
Smrekarjeva 1
3000 Celje
tel: 03 490 7002
fax: 03 541 3001
mateja.percic@rubico-trade.si

South Africa

Third Avenue Trading C.C.
PO Box 3214
2121 Parklands
Tel.: + 27 11 2 662 379
Fax: + 27 11 3 271 131
tat1@hvi.co.za

Spain

Guitarre Distribuciones, S.L.
Pol.Ind.Mallolas, Masias de Roda, 10
ES-08500 Vic
Tel.: +34 93 8 891 338
Fax: +34 93 8 814 685
albert@guitarre.com

Sweden

Berg & Nycander AB
Box 107
S-17822 Ekeröe
Tel.: +46 8 56 031 070
Fax: +46 8 56 031 565
caroline@bony.se

Switzerland

Mayer & Bosshardt AG
Riehenring 175/2. Stock
CH-4058 Basel
Tel.: +41 61 6 909 730
Fax: +41 61 6 909 731
bosshardt@mbag.ch

United Arab Emirates

4 Homes FZ Co.
P.O. Box 62688
Dubai
Tel.: +971 4 8813 383
Fax: +971 4 88 173 393
nazia@4homes.ae

Uruguay

Impex International S.A.
Marcelino Sosa 2326
11800 Montevideo
Tel.: +598 2 2 082 972
impex@redfacil.com.uy

USA

Frieling
398 York Southern Rd
Fort Mill, SC 29715-7715
T: 803-548-2000
F: 803-548-2060
mfs@frieling.com
www.frieling.com

Kontakt / contact

KÜCHENPROFI GmbH

42699 Solingen · Höhscheider Weg 29
42669 Solingen · Postfach 110925

Telefon: +49 (0) 212 / 65 82 - 0

Fax: +49 (0) 212 / 65 82 - 33 (Verkauf Inland)
+49 (0) 212 / 65 82 - 26 (Verkauf Export)

Internet: www.kuechenprofi.de

e-mail Verkauf Inland: verkauf@kuechenprofi.de

e-mail Verkauf Export: export@kuechenprofi.de

Geschäftsführer

Willy E. Schnarrenberger
Stefan Schmitz

Verkaufsleitung

Klaus Merten

Key Account

Werner Spedale
Kordula Schmidt

Export

Claudia Kaldasch

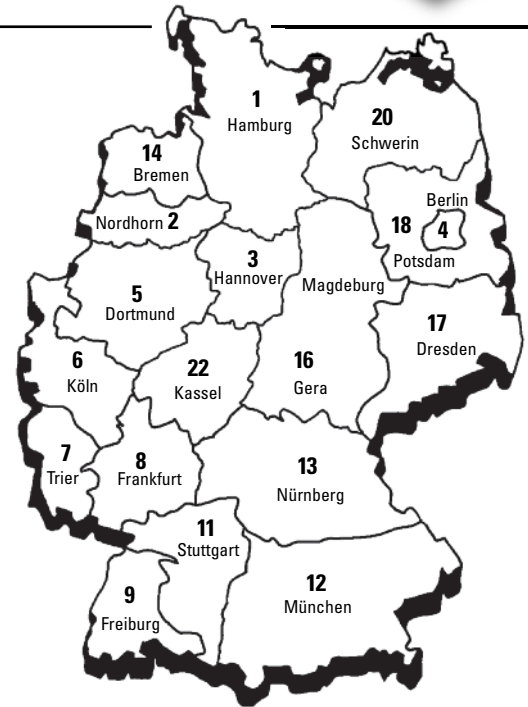

1 Hamburg, Schleswig-Holstein, Bremen,

2 Norbert Jester

Rahnstraße 25
D-22179 Hamburg

Telefon: 0 40 / 6 420 139

Telefax: 0 40 / 6 415 530

Mobil: 0 172 / 4 118 509

e-mail: n.jester@kuechenprofi.de

14

3 Westfalen, Hannover,
westliches & östliches Niedersachsen

5 Stefan Herkströter

Overhove 2
D-33803 Steinhausen

Telefon: 05 204 / 80 709

Telefax: 05 204 / 80 397

Mobil: 0 172 / 5 322 316

e-mail: s.herkstroeter@kuechenprofi.de

4 Berlin, Brandenburg, Sachsen-Anhalt

18 Bernhard Zawadzki

Mühlenstraße 6
34346 Hannoversch-Münden

Telefon: 05 541 / 955 872

Telefax: 05 541 / 955 757

Mobil: 0 178 / 8 080 560

e-mail: b.zawadzki@kuechenprofi.de

6 Niederrhein, Kölner Bucht, Eifel, Siegtal,
Bergisches Land, PLZ-Gebiet 56, Luxemburg

24 Christian Schnarrenberger

Weckshof 11
D-42657 Solingen

Telefon: 0 212 / 2 256 782

Telefax: 0 212 / 22 579 984

Mobil: 0 176 / 22 883 426

e-mail: ch.schnarrenberger@kuechenprofi.de

8 südl. Nordrhein-Westfalen

22 Klaus Katzmarzik

Burgstraße 9
D-35444 Biebertal

Telefon: 06 409 / 804 770

Telefax: 06 409 / 804 769

Mobil: 0 172 / 2 662 511

e-mail: k.katzmarzik@kuechenprofi.de

9 Baden-Württemberg

11 Andreas Pritzl

Heilig-Brünne-Str. 82/1
D-72461 Albstadt-Truchelfingen

Telefon: 07 432 / 9 840 490

Telefax: 07 432 / 9 840 492

Mobil: 0 172 / 6 234 873

e-mail: a.pritzl@kuechenprofi.de

12 Bayern, Franken

13 Manfred Weißenberg

Buchgasse 7
D-92715 Püchersreuth

Telefon: 09 602 / 37 112

Telefax: 09 602 / 37 112

Mobil: 0 151 / 14 123 117

e-mail: m.weissenberg@kuechenprofi.de

16 Thüringen,
Sachsen, Sachsen-Anhalt

17 Marko Heim

Untere Hauptstraße 29
D-09244 Lichtenau b. Chemnitz

Telefon: 037 208 / 88 898

Telefax: 037 208 / 88 897

Mobil: 0 177 / 2 341 956

e-mail: m.heim@kuechenprofi.de

20 Mecklenburg-Vorpommern

Carl Peter Fosseck

Thorkoppel 1
D-22885 Barsbüttel

Telefon: 040 / 6 701 537

Telefax: 040 / 6 704 049

Mobil: 0 173 / 2 708 155

Für Bestellungen gelten unsere in der Preisliste aufgeführten Allgemeinen Geschäftsbedingungen.

Änderungen im Sortiment behalten wir uns vor.

index

A		
all-purpose tongs	93	
anti splash sieve	43	
apple corer	47, 98	
apple divider	47	
apron for children	38	
asparagus peeler	60	
asparagus pot	60	
asparagus tongs	48	
attachment for pasta machine	23, 24	
B		
bain marie pot	121	
baking beans	37	
baster set	76	
BBQ basket	89, 91	
BBQ brush	95	
BBQ gloves	93	
BBQ pan	91	
BBQ set	95	
BBQ skewers	92	
BBQ tongs	93	
BBQ tongs for fish	89	
board	126, 127	
bowl	121	
braising pot	6, 8, 9	
bread box	40	
breeding set	42	
breakfast board	126	
butter dish	46	
butter melter	121	
C		
cake lifter	38	
cake pop set	32	
cake ring	35	
cake thermometer	38	
can opener	98, 110	
candy thermometer	50	
ceramic hob cleaner	109	
cheese cutter	100	
cheese fondue casserole	114	
cheese grater	69, 109	
cheese knife	97	
cheese plane	98	
chicken leg holder	90	
chicken roast rack	90	
chili mill	134	
chocolate set	32	
closing clips	109	
coffee maker	84	
colanders	43, 122	
confectionery funnel	31	
cookie cutter	33	
cookie stamp	33	
cooking spoon holder	53	
cooking tweezers	93	
cooling rack	35	
cord box	75	
corn holder	92	
Crème Brûlée dish	15, 118	
Crème Brûlée set	118	
Crème Brûlée torch	118	
crinkle cutter	47	
cucumber slicer	63, 68	
cup cake mould	34	
cutting board	126, 127	
decorating rings	44	
D		
decorating set	31, 34	
decorating squeeze bottle	34	
decoration cutter	45	
deep baker	13, 16, 17	
deep fry thermometer	77	
dessert rings	44	
dessert server	98	
dish draining rack	87	
dish washing brush	86, 101	
double boiler	121	
double slicer	63	
dredger	56, 131	
dressing shaker	109	
dryer balls	86	
E		
egg beater	109	
egg cup	14	
egg lifter	100	
egg pricker	108	
egg ring	86	
egg separator	108	
egg shell topper	108	
egg slicer	108	
F		
fat separator jug	76	
finger protector	68	
fish / asparagus tongs	48	
fish scaler	48	
fishbone tweezers	48	
flan dish	14, 19, 36	
flat colander	43	
flavour grater	47	
flour sieve	37	
foam cup	84	
fondue forks	115	
fondue plate	114	
fondue set	115	
fondue spoon	114	
food mill	51	
french oven	6, 9	
fry pan	7, 10	
fuel paste	114	
funnel	50	
G		
garlic peeler	104	
garlic plane	104	
garlic press	104	
garnishing injection	34	
garnishing spoon	30	
gas torch	118	
gourmet marinade injector	76	
gourmet set	32	
gourmet skewers	75	
grater	62, 64 - 68	
grill board	91	
grill pan	7, 10	
H		
hamburger grilling basket	94	
hamburger press	94	
hamburger turner	94	
hand guard	64 - 66	
herb canister	56	
herb scissors	124, 125	
hourglass	73	
I		
icecream scoop	86	
icing bag	34	
icing set	31	
icing spatula set	35	
J		
jacket potato fork	46	
jam funnel	50	
jar and bottle opener	110	
julienne cutter	47	
K		
kitchen scales	41	
kitchen scissors	124, 125	
larding needle	75	
L		
lasagna pan	120	
lemon squeezer	15, 110	
lemon zester	97	
lid for lasagna/roasting pan	120	
linzer cookie cutter	33	
lobster forks	87	
lobster tongs	87	
lunchbox	53	
M		
macaron set	32	
magnetic knife rack	101	
marinade set	91	
measuring cup	37	
meat clamp	75	

index

meat cleaver	42	potato masher	99, 101	steaming insert	86
meat fork	99	potato press	105	strainer	102
meat grinder	37	potato rack	90		
meat pounder	42	poultry scissors	46, 124	T	
meat press	94	pour off sieve	43	tarte flambée paddle	28
melon baller	97	pudding bowl	14	tartlets set	31, 32
microwave dish	13	pudding mould	35	tea / spice tongs	80
milk frother	84			tea bag clips	81
mincing knife	58	Q		tea bag holder	81
mini casserole	11	quiche pan	36	tea bag tongs	80
mini pot	121			tea ball	80, 81
mixing bowl	121, 122	R		tea glasses	82
mortar	57	raclette	112	tea pot	82, 83
motor for pasta machine	23	raclette saucer	112	tea strainer	80, 81, 102
multi chopper	106	raclette spatula	113	tea warmer	81
mushroom brush	51	ramekin	14, 15, 18	Teaboy	79
		rasp	67	thermometer	38, 50, 77
N		ravioli cutter	25	timer	71 - 73
nut cracker	84	ravioli mould	25	tomato corer	46
nutmeg grater	56, 68, 97	ravioli stamp	25	tomato slicer	106
nutmeg mill	56	refrigerator thermometer	77	tongs	87, 89, 93
nylon turner	98	ring for fried egg	86	trivet	43
		roast thermometer	77	truffle plane	43, 99
O		roast tongs/holder	110	tureen dish	15
odor absorber	110	roasting pan	7, 10, 120	tureen mould	45
oil dispenser	58	rolling pin	37	turner	99
olive oil sprayer	58	roulade needles	75	turning fork	48
oven gloves	76, 93	roulade rings	75		
oven mitt	76			U	
oven thermometer	77	S		utensil rack	100
oyster glove	87	salad spinner	107, 108		
oyster knife	97	salt	131	V	
		salt mill	132 - 135	vegetable brush	51
P		sandglass	73	vegetable peeler	58, 60
paella pan	8, 10	sauce ladle	99	vegetable slicer	63
palette	98	saucepan	60, 121	vinegar sprayer	58
palette knife	97	scales	41		
paper towel holder	54	scissors	124, 125	W	
parsley/herb mill	106	serving spoon	99	warmer for saucepan	60
pasta drying stand	24	serving tongs	48	whisk	100, 101
pasta machine	21, 22, 24	s-hook	100	wok set	8, 10
pasta pot	120	sieve	43, 51, 102		
pastry cutter	97	skewers	75	Z	
pastry scraper	37, 38	skimmer	26, 99	zester	65 - 67, 97
pastry spoon set	31	soap, stainless steel	104		
peeler	98	soup ladle	99		
pepper	131	spaetzle lid	26		
pepper mill	131 - 135	spaetzle maker	26		
pie dish	15	spaetzle plane	26		
pineapple slicer	106	spaetzle press	105		
pizza cutter	28, 97	spaghetti measure	25		
pizza paddle	28	spaghetti server	100		
pizza server	38	spice ball	81		
pizza stone	28	spice grater	68		
plate warmer	116	spice rack	129, 130		
pot set	120	spiral cutter	47		
potato / spaetzle press	26	spoon holder	53		
potato cutter	105	spoon rest	53		
potato grater	63	springform pan	36		

Inhalt

A		E		H	
Abgieß-Sieb	43	Eierbecher	14	Hähnchengriller	90
Abtropfgestell	87	Eierköpfer	108	Hamburger-Grillzange	94
Allzweckzange	93	Eierschneider	108	Hamburger-Presser	94
Ananasschneider	106	Eieruhr	73	Hamburger-Wender	94
Apfelausstecher	98	Eierwender	37, 100	Haushaltsschere	124
Apfelteiler	47	Eipicker	108	Hummergabeln	87
Aromabräter	120	Eisportionierer	86	Hummerzange	87
Aromareibe	47	Ei-Trenner	108		
Auflaufform	13, 16	Espressokocher	84	J	
Aufsatz für Nudelmaschine	23, 24	Essig-Sprüher	58	Julieneschneider	47
Aufschäumbecher	84			Julienne-Set	47
Ausstecher	33	F			
Austernbrecher	97	Fett-Trennkanne	76	K	
Austernhandschuh	87	Finger-Schneidschutz	68	Kartoffel-/Spätzlepresse	26
		Fisch-/Spargelzange	48	Kartoffelpresse	105
B		Fischentschupper	48	Kartoffelreibe	63
Backofen-Thermometer	77	Fischgräten-Pinzette	48	Kartoffelstampfer	99, 101
Bauernform	13	Fischgrillzange	89	Käsehobel	98
Bauernpfanne mit Glasdeckel	6, 9	Flammkuchenbrett	28	Käsemesser	97
Bayrischer Bräter	120	Fleischbeschwerer	94	Käsereibe	69, 109
BBQ-Set	95	Fleischgabel	99	Käseschneider	100
Blindbackkugeln	37	Fleischklopper	42	Keks-Stempel	33
Brat-/Grillzange	93	Fleischwolf	37	Kinderschürze	38
Brat-/Wendepinzette	93	Fondant-Trichter	31	Knoblauchpresse	104
Braten-/Gewürzspritze	76	Fonduegabeln	115	Knoblauchschäler	104
Bratenthermometer	77	Fondue-Set	115	Knoblauchschneider	104
Bratentopf mit Gussdeckel	6, 9	Fondueteller	114	Kochlöffelständer	53
Bratenzange / Schneidehilfe	110	Frittierthermometer	77	Kombi-Thermometer	77
Bratpfanne	7, 10	Frühstücksbrett	126	Kompaktseife	104
Bratreine	7, 10, 120			Konditormesser-Set	35
Brennpaste	114	G		Kordelbox	75
Brett	126, 127	Garnierspritze	34	Kräuterschere	124, 125
Brotkästen	40	Gasbrenner	118	Küchenbeil	42
Brühsieb	122	Geflügelschere	46, 124	Kuchengitter	35
Butterdose	46	Gemüsebürste	51	Kuchenretter/Pizzaheber	38
Butterpfännchen	60, 121	Gemüsehobel	63	Küchenschere	124, 125
		Gemüseschäler	58, 60	Küchensieb	102
C		Gemüsesehier	122	Kuchenthermometer	38
Caquelon	114	Gestell für Hühnerschenkel	90	Küchenwaage	41
Champignonbürste	51	Gewürz-/Marinadenspritze	76	Kühlschrank-Butterdose	46
Chilimühle	134	Gewürzgläser	56	Kühlschrank-Geruchskiller	110
Crème Brûlée - Brenner	118	Gewürzkugel	81	Kühlschrank-Thermometer	77
Crème Brûlée - Schale	15, 118	Gewürzreibe	68		
Crème Brûlée - Set	118	Gewürzständer	129, 130	L	
		Glaskeramik-Reiniger	109	Lasagneform	13, 17
D		Gourmethobel	99	Linzer-Ausstecher	33
Dämpfeinsatz	86	Gourmetpfanne	6, 8, 9	Löffelablage	53
Deckel zu Bayrischem Bräter	120	Gourmet-Set	32	Lunchbox	53
Dekorier-/Garnier-Set	34	Gourmetspieße	75		
Dekorierflasche	34	Grillbretter	91	M	
Dekorierlöffel	30	Grillbürste	95	Macaron-Set	32
Dekorierschneider	45	Grillgemüse-Korb	89	Magnetleiste	101
Dekorier-Set	31	Grillhandschuhe	93	Maiskolbenhalter	92
Dessert-/Vorspeisenringe	44	Grillkartoffel-Halter	90	Marinaden-Set	91
Dessertportionierer	98	Grillkorb	91	Marmeladentrichter	50
Dosenöffner	98, 110	Grillpfanne	7, 10, 91	Meersalz	131
Dressingshaker	109	Grillspieße	92	Mehlsieb	37
		Grillzange	93	Melonenausstecher	97
		Gurkenhobel	63, 68		

Inhalt

Messbecher	37	Rechaud für Butterpfännchen	60	Tartelett-Set	31, 32
Mikrowellenform	13	Reiben	62, 64 - 68	Teaboy	79
Milchaufschäumer	84	Restehalter	64 - 66	Tee-/Gewürzkugel	80, 81
Mini-Töpfchen	11, 121	Rettichschneider	47	Tee-/Gewürzzange	80
Mörser	57	Rouladenklammern	75	Teebeutel-Halter	81
Motor für Nudelmaschine	23	Rouladennadeln	75	Teebeutel-Klammer	81
Muffin-Form	34	Rouladenringe	75	Teebeutel-Zange	80
Multibräter	120	Rührlöffel-Set	31	Teefilter	80
Multischneider	106	Rührschüssel	121	Teegläser	82
Multizange	93	Rundschüssel	122	Teekanne	82, 83
Muskatmühle	56			Teesieb	80, 81, 102
Muskatreibe	56, 68, 97			Teigrädchen	97
		S		Teigrolle	37
		Salatschleuder	107, 108	Teigschaber	37, 38
		Salzmühlen	132 - 135	Tellerwärmer	116
		Sanduhr	73	Terrinenform	15, 45
		Saucenlöffel	99	Thermometer	38, 50, 77
		Schaumlöffel	26, 99	Timer	71 - 73
		Scheren	124, 125	Tomatenschneider	106
		Schlemmerform	13	Tomatenstrunkentferner	46
		Schneebesens	100, 101	Topfhandschuh	76
		Schneeschläger	109	Topf-Set	120
		Schneidebrett	126, 127	Tortelettförmchen	14
		Schöpflöffel	99	Tortenform	14, 19
		Schüssel	121, 122	Tortenring	35
		Seiher	122	Trichter	50
		Servierlöffel	99	Trocknerbälle	86
		Servierzange	48	Trüffelhobel	43
		Setzei-Ring	86	Türkisch Mocca-Becher	84
		S-Haken	100		
		Siebe	43, 102		
		Siebeinsatz	43	U	
		Siedelöffel	114	Universalöffner	110
		Silikon-Teigschaber	37	Untersetzer	43
		Spaghettiheber	100		
		Spaghetti-Maß	25	V	
		Spargelkocher	60	Verschlussklammern	109
		Spargelschäler	60	Vorspeisenringe	44
		Spargelzange	48		
		Sparschäler	98	W	
		Spätzle-Ass	26	Waage	41
		Spätzle-Hobel	26	Wandküchenleiste	100
		Spätzlepresse	105	Wasserbad-Topf	121
		Spätzlereibe	26	Wellenschneider	47
		Spicknadel	75	Wendegabel	48
		Spieße	75, 92	Wender	99
		Spiralschneider	47	Wiegemesser	58
		Spitzsieb	102	Wok-Set	8, 10
		Springform	36		
		Spritzbeutel-/Dekorier-Set	34	Z	
		Spritzbeutel-Set	31	Zange	87, 89, 93
		Spritzschuttsieb	43	Zester	65 - 67, 97
		Spülbürste	86, 101	Zitronenpresse	15, 110
		Stempel für Kekse	33	Zitronenzester	97
		Stielkasserolle	121	Zuckerthermometer	50
		Stövchen	81	Zweifachhobel	63
		Streuer	56, 131		
		T			
		Tarte- und Quicheform	36		
		Tartelettform	36		
N					
Nudelmaschine	21, 22, 24				
Nudeltrockner	24				
Nussknacker	84				
Nylonwender	98				
O					
Ofenhandschuhe	76, 93				
Olivenöl-Sprüher	58				
Öl-Spender	58				
P					
Paellapfanne	8, 10				
Palette	98				
Palettenmesser	97				
Panier-Set	42				
Papierrollenhalter	54				
Passiergerät	51				
Passiersieb	51, 122				
Pastatopf	120				
Pastetenform	15				
Pellkartoffel-Set	46				
Petersilien-/Kräutermühle	106				
Pfannen-/Wendegabel	48				
Pfeffer	131				
Pfeffermühlen	131 - 135				
Pizzaheber	38				
Pizza-Schieber	28				
Pizzaschneider	28, 97				
Pizza-Stein	28				
Plätzchen-Ausstecher	33				
Pommes Frites-Schneider	105				
Popcake-Set	32				
Pralinen-Set	32				
Puddingform	14, 35				
R					
Raclette	112				
Raclette-Brettchen	112				
Raclette-Schaber	113				
Ragoutschälchen	14, 15, 18				
Raspel	67				
Ravioliausstecher	25				
Raviolibrett	25				
Ravioli-Former	25				
Ravioli-Rad	25				



KÜCHENPROFI GmbH
42699 Solingen · Höhscheider Weg 29
42669 Solingen · Postfach 110925

Tel.: +49 (0) 212/6582-0
Fax: +49 (0) 212/6582-10/-33

e-mail: verkauf@kuechenprofi.de
Internet: www.kuechenprofi.de

GERMANY

© KÜCHENPROFI
Katalog 2015 3/15/7500/0149 ME
Art.-Nr. 00.1002 00 00